

SATURN SLIM II 80 P/N-Z, W

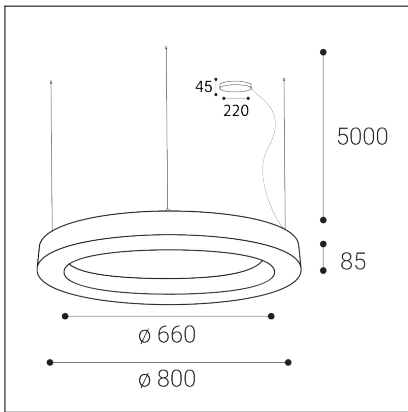

Code:	3276471DT
Color:	WHITE / 9003
Material:	ALUMINIUM/PMMA
Power:	80W (50+30)
Color temperature:	2700K/3000K/4000K
Lumen output:	3500+2100lm
Efficacy:	70lm/W
Color rendering index:	90+
SDCM:	< 3
Light beam angle:	90°
Unified Glare Rating:	< 19
Light Source:	LED
Dimmable:	TRIAC
LED lifetime:	L80B20 50.000h
Driver:	1300 + 750 mA
Voltage / Frequency:	220-240V AC, 50-60Hz
Dimensions luminaire:	d800x85 mm
Product weight kg:	7.5
Length suspension:	5000 mm
Package dimensions:	850x850x120 mm

