

OPLIGHT W1

Designed by Jasper Morrison, 2021

F4681032

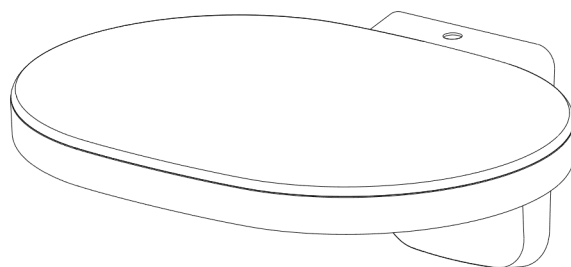

OPLIGHT W1

F4681032

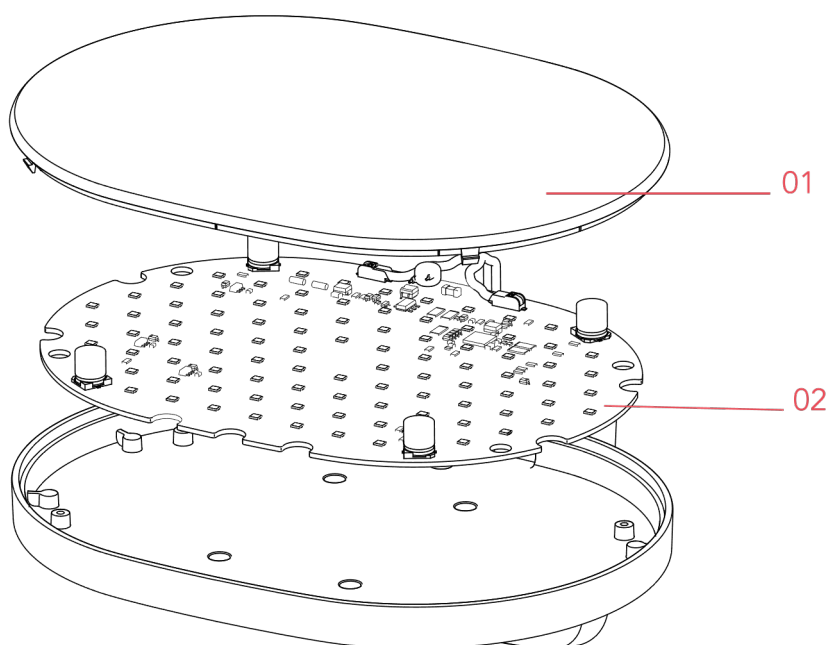
EN

01. RF31153 – W1 diffuser

02. RF4681100 – Led Chip board

OPLIGHT W1 F4681032

EN

RF31153

W1 DIFFUSER



WARNING! When installing and whenever acting on the appliance, ensure that the power supply has been switched off.
For the installation of the spare-part, it is necessary to consult a qualified electrician.

©2021 Flos - All rights reserved - www.flos.com

Flos reserves the right to introduce any changes to its own models, without prior notice.

OPLIGHT W1 F4681032

EN

RF31153

W1 DIFFUSER

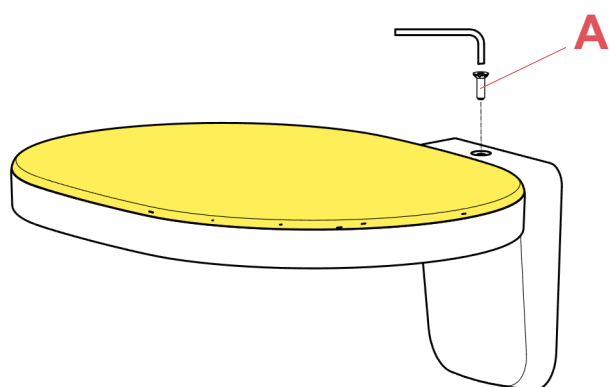

Fig.1

Unscrew the screw (A).

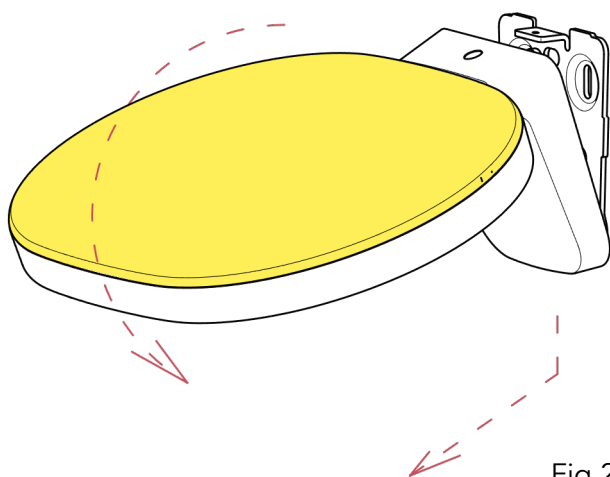

Fig.2

Remove the body lamp from the wall attach.

WARNING! When installing and whenever acting on the appliance, ensure that the power supply has been switched off.
For the installation of the spare-part, it is necessary to consult a qualified electrician.

OPLIGHT W1 F4681032

EN

RF31153

W1 DIFFUSER

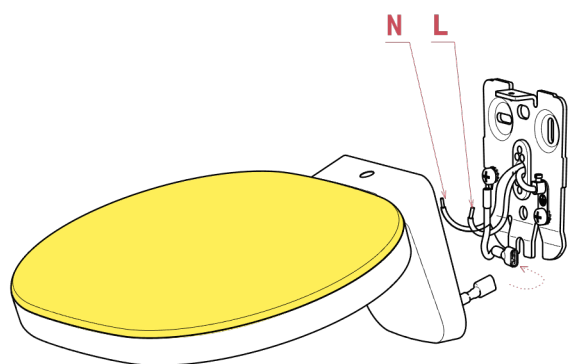

Fig.3

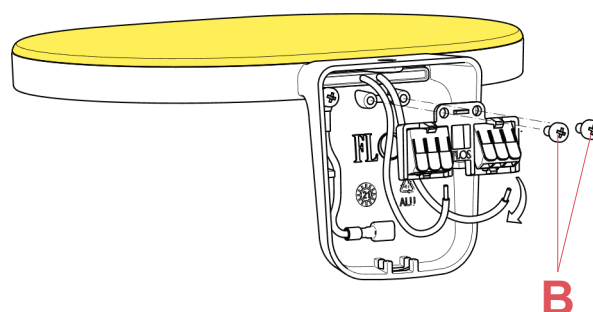

Fig.4

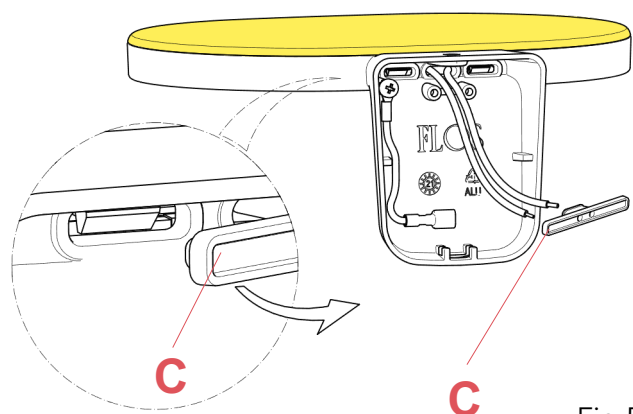

Fig.5

Disconnect the electrical cables (L-N) from the cable clamp.(Fig.3)

Remove the n° 2 screws (B).(Fig.4)

Remove the rubber cable gland (C).(Fig.5)

WARNING! When installing and whenever acting on the appliance, ensure that the power supply has been switched off.
For the installation of the spare-part, it is necessary to consult a qualified electrician.

OPLIGHT W1 F4681032

EN

RF31153

W1 DIFFUSER

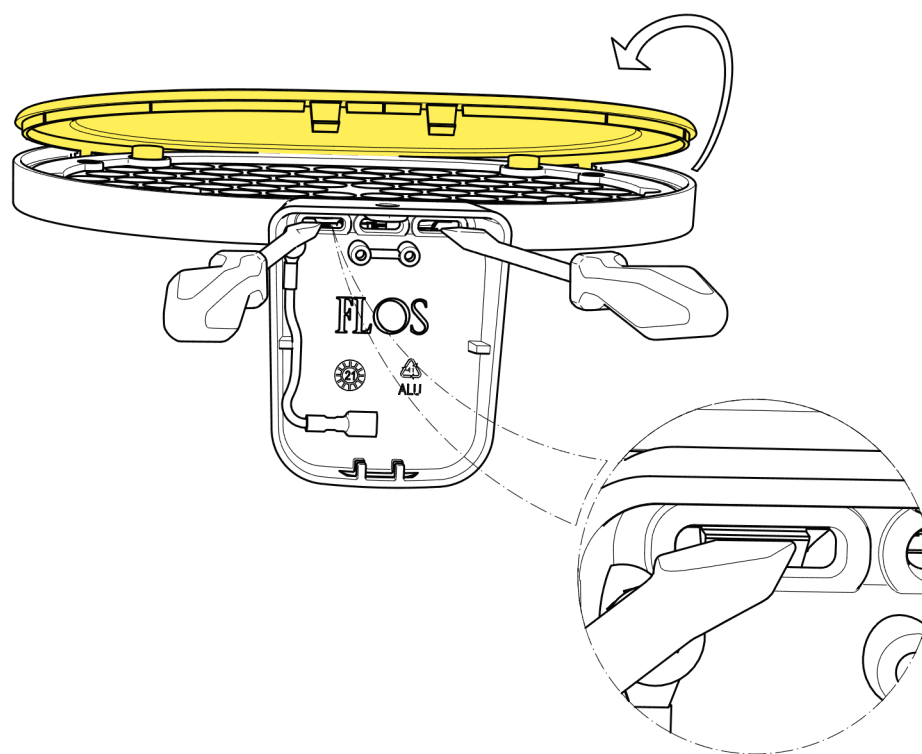

Fig.6

Using a cut screwdriver force the white plastic diffuser and remove it from body lamp.
Replace the old diffuser with the new one.

WARNING! When installing and whenever acting on the appliance, ensure that the power supply has been switched off.
For the installation of the spare-part, it is necessary to consult a qualified electrician.

OPLIGHT W1 F4681032

EN

RF4681100

LED CHIP BOARD

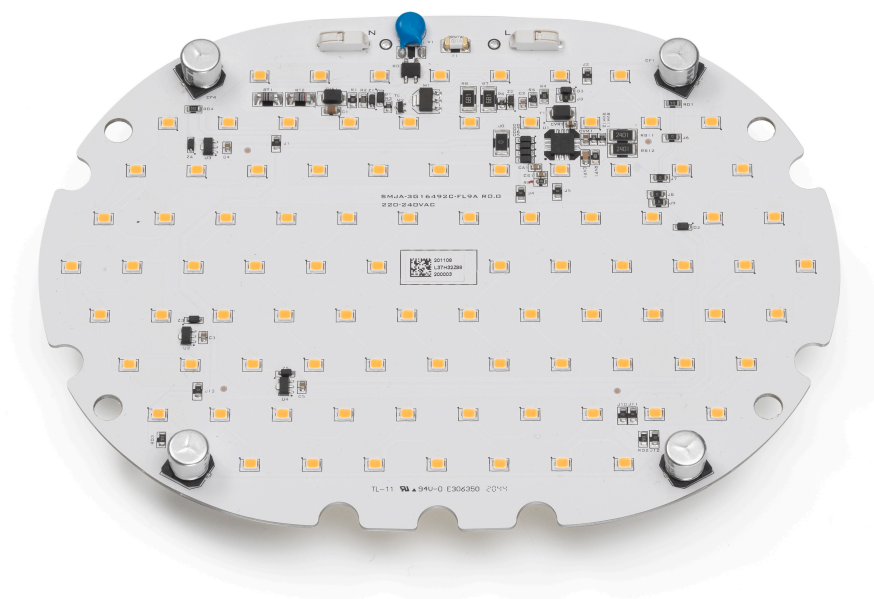

WARNING! When installing and whenever acting on the appliance, ensure that the power supply has been switched off. For the installation of the spare-part, it is necessary to consult a qualified electrician.

OPLIGHT W1 F4681032

EN

RF4681100

LED CHIP BOARD

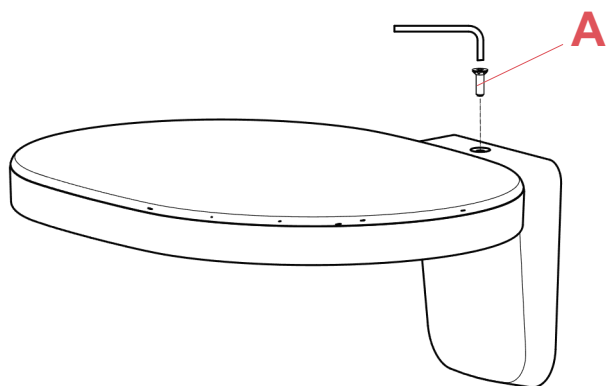

Fig.1

Unscrew the screw (A).

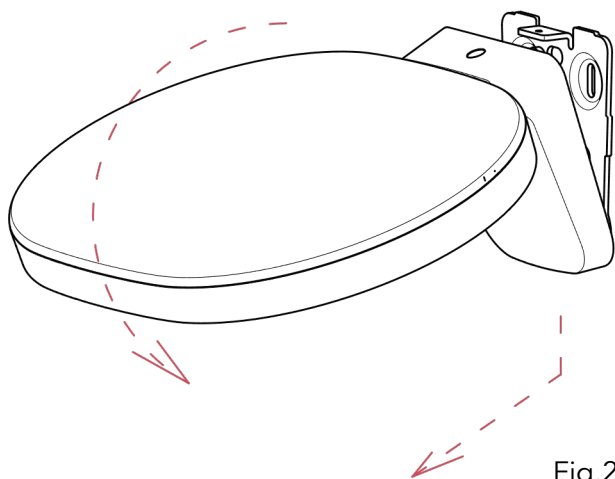

Fig.2

Remove the body lamp from the wall attach.

WARNING! When installing and whenever acting on the appliance, ensure that the power supply has been switched off.
For the installation of the spare-part, it is necessary to consult a qualified electrician.

OPLIGHT W1 F4681032

EN

RF4681100

LED CHIP BOARD

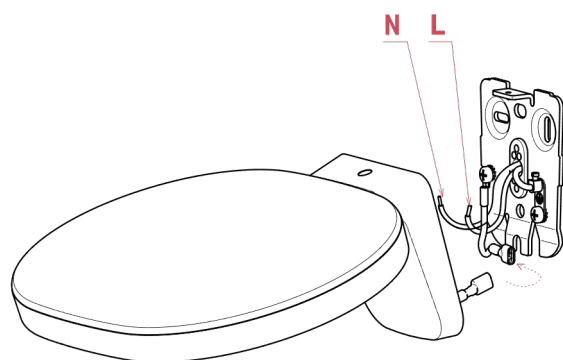

Fig.3

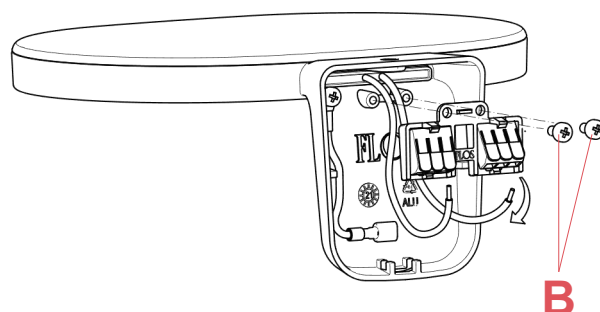

Fig.4

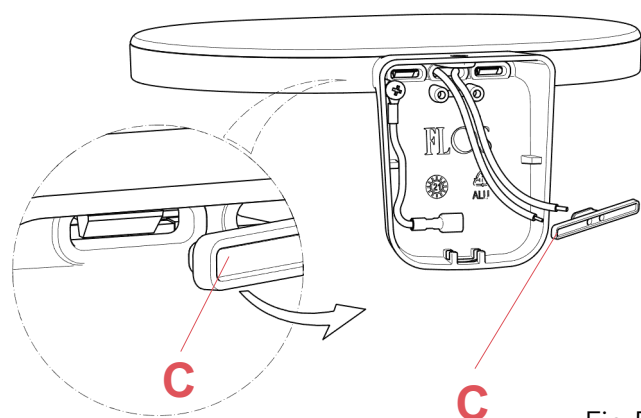

Fig.5

Disconnect the electrical cables (L-N) from the cable clamp.(Fig.3)

Remove the n° 2 screws (B).(Fig.4)

Remove the rubber cable gland (C).(Fig.5)

WARNING! When installing and whenever acting on the appliance, ensure that the power supply has been switched off. For the installation of the spare-part, it is necessary to consult a qualified electrician.

OPLIGHT W1 F4681032

EN

RF4681100

LED CHIP BOARD

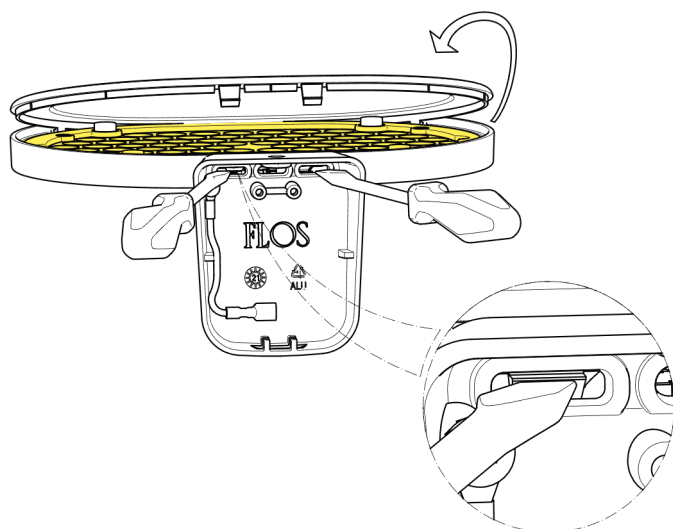

Fig.6

Using a cut screwdriver force the white plastic diffuser and remove it from body lamp.

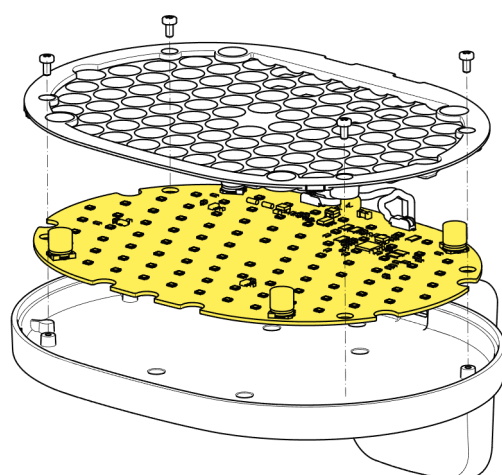

Fig.7

Unscrew the n°4 screws and remove the white plastic grid.

WARNING! When installing and whenever acting on the appliance, ensure that the power supply has been switched off. For the installation of the spare-part, it is necessary to consult a qualified electrician.

OPLIGHT W1 F4681032

EN

RF4681100

LED CHIP BOARD

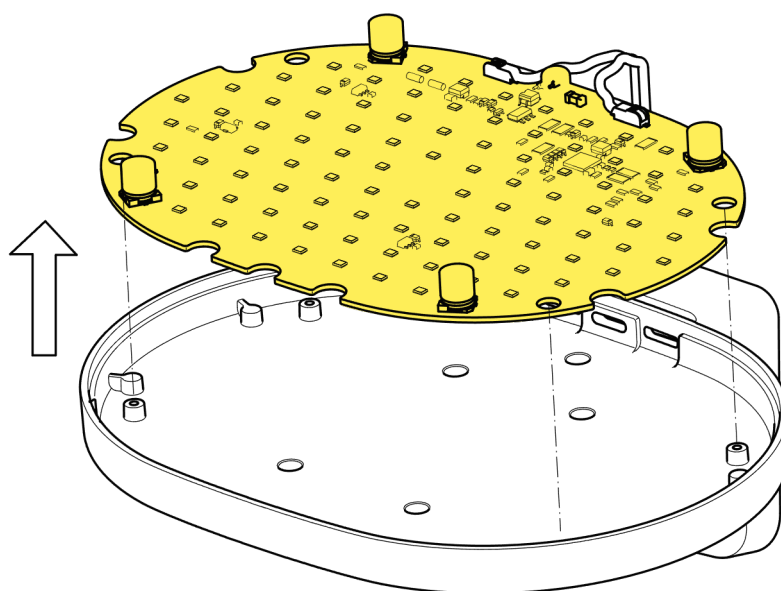

Fig.8

Remove and replace the led chip board.

Assemble now the new spare part.

Position the plastic grid on the led chip board and screw the n°4 screws. (Fig.7)

Fix the diffuser to the body lamp.

Pass the cables through the white plastic support.(Fig.5)

Connect the electrical cables to the cable clamps and screw the n°2 screws.(Fig.4)

Fix the body lamp to the wall attach.

Screw the screw (A).

WARNING! When installing and whenever acting on the appliance, ensure that the power supply has been switched off.
For the installation of the spare-part, it is necessary to consult a qualified electrician.