

SERIES: ASPHO, BERIEL, ELIN, GUDE, ILAMT, NITUM, TURE, ENVELOPE

BRAND: i-L^{ED}

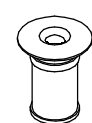

ASPHO_R
A

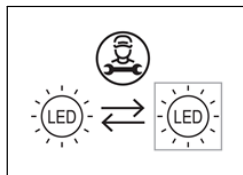

ASPHO_Q
B

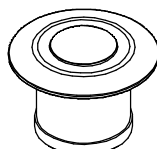

NITUM_R
C

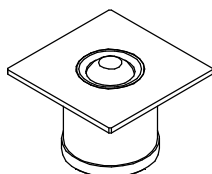

NITUM_Q
D

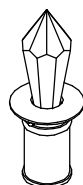

BERIEL
E



ELIN
F

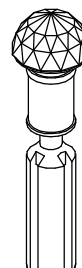

TURE
G

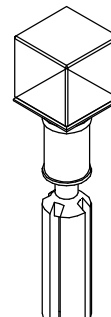

GUDE
H

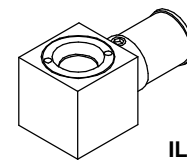

ILAMT
I

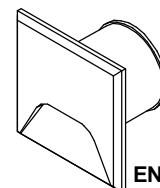

ENVELOPE
L

CODICI / CODES

CODE	Type	Dimensions (Q x H mm/ Ø x H mm)	POWER (W DC)	CLASS III		WEIGHT (Kg)	CRI	IP	Energy class light source					No. light source	Conn. Type	
				VOLTAGE (V)					Temperature color LED (°K)							
					CURRENT (mA)				2700	3000	4000	5000	RGB			
88417	ASPHO_R	Ø20 x 23	0,5	C.V. 24	/	0,015	80	44	F	G	N/A	G	N/A	1	Y	
85001		Ø20 x 23	0,5	C.V. 24	/	0,015	80		N/A	G	N/A	G	N/A	1		
85002		Ø20 x 23	0,5	C.V. 24	/	0,015	80		N/A	G	N/A	G	N/A	1		
91352 *		Ø20 x 23	1,5	C.V. 24	/	0,015	N/A		N/A	N/A	N/A	N/A	N/A	1		
86707 *		Ø20 x 23	1,5	C.V. 24	/	0,015	N/A		N/A	N/A	N/A	N/A	N/A	1		
86708 *		Ø20 x 23	1,5	C.V. 24	/	0,015	N/A		N/A	N/A	N/A	N/A	N/A	1		
C00263		Ø20 x 23	1	3		350	0,015		90	F	F	E	N/A	N/A		1
C00264		Ø20 x 70	1,5			500	0,039		90	F	F	E	N/A	N/A		1
C00267		Q20 x 23	1			350	0,017		90	F	F	E	N/A	N/A		1
C00268		ASPHO_Q	Q20 x 70	1,5		500	0,039		90	F	F	E	N/A	N/A		1
C00269	NITUM_R	Ø40 x 23	1	9	350	0,058	90	F	F	E	N/A	N/A	1			
C00273		Ø40 x 45	2		630	0,07	90	F	F	E	N/A	N/A	1			
88568 *		Ø40 x 45	2,1		220	0,072	N/A	N/A	N/A	N/A	N/A	N/A	1			
86612 *		Ø40 x 45	2,1		220	0,072	N/A	N/A	N/A	N/A	N/A	N/A	1			
86613 *		Ø40 x 45	2,1		220	0,072	N/A	N/A	N/A	N/A	N/A	N/A	1			
86674 *	Ø40 x 45	2,1			220	0,072	N/A	N/A	N/A	N/A	N/A	1				
C00275	NITUM_Q	Q40 x 24,5	1	9	350	0,06	90	F	F	E	N/A	N/A	1			
C00276		Q40 x 45	2		630	0,073	90	F	F	E	N/A	N/A	1			
88569 *		Q40 x 45	2,1		220	0,079	N/A	N/A	N/A	N/A	N/A	N/A	1			
86614 *		Q40 x 45	2,1		220	0,079	N/A	N/A	N/A	N/A	N/A	N/A	1			
86615 *		Q40 x 45	2,1		220	0,079	N/A	N/A	N/A	N/A	N/A	N/A	1			
86675 *	Q40 x 45	2,1			220	0,079	N/A	N/A	N/A	N/A	N/A	1				
C00283	BERIEL	Ø20 x 53	1	3	350	0,019	90	20	F	F	E	N/A	N/A	1		
C00284		Ø20 x 100	1,5		500	0,056	90		F	F	E	N/A	N/A	1		
87340 *	ELIN	Ø20 x 35	0,5	C.V. 24	/	0,015	N/A	N/A	N/A	N/A	N/A	1				
C00292		Ø20 x 35	1	350	0,05	90	F	F	E	N/A	N/A	1				
C00293		Ø20 x 78	1,5	500	0,07	90	F	F	E	N/A	N/A	1				
C00294	TURE	Ø21 x 81	1,5	3	500	0,045	90	52	F	F	E	N/A	N/A	1		
C00295		Ø31 x 77	1,5		500	0,08	90		F	F	E	N/A	N/A	1		
C00296		Ø41 x 61	1,5		500	0,094	90		F	F	E	N/A	N/A	1		
C00297	GUDE	Q20 x 88	1,5	3	500	0,057	90	54	F	F	E	N/A	N/A	1		
C00298		Q30 x 90	1,5		500	0,124	90		F	F	E	N/A	N/A	1		
C00299		Q40 x 82	1,5		500	0,226	90		F	F	E	N/A	N/A	1		
C00244	ILAMT	Q22 x 46	1	3	350	0,072	90	44	F	F	E	N/A	N/A	1		
C00245	ILAMT	Q30 x 50	2		630	0,191	90		F	F	E	N/A	N/A	1		
C00246	ILAMT 66	Q30 x 50	2		630	0,174	90		F	F	E	N/A	N/A	1		
C00227	ENEVELOPE_1	Q40 x 25	1	3	350	0,077	90	66	F	F	E	N/A	N/A	1		
C00228	ENEVELOPE_2	Q40 x 25	1		350	0,077	90		F	F	E	N/A	N/A	1		
C00229	ENEVELOPE_3	Q40 x 25	1		350	0,077	90		F	F	E	N/A	N/A	1		

Ta: -20°C / +50°C

*RGB

SERIES: ASPHO, BERIEL, ELIN, GUDE, ILAMT, NITUM, TURE, ENVELOPE

BRAND: i-L^èD

INSTALLAZIONE SU CARTONGESSO / INSTALLATION ON DRYWALL

CODE	Type	X ∅ [mm]
88417	ASPHO_R	15
85001		
85002		
91352		
86707		
86708		
C00263		
C00264	ASPHO_Q	
C00267		
C00268	NITUM_R	29
C00269		
C00273		
88568		
86612		
86613		
86674		
C00275	NITUM_Q	
C00276		
88569		
86614		
86615	BERIEL	15
86675		
C00283		
C00284	ELIN	
87340		
C00292		
C00293	TURE	20
C00294		
C00295		
C00296	GUDE	29
C00297		
C00298		
C00299	ILAMT	15
C00244		
C00245		
C00246	ILAMT	20
C00227		
C00228		
C00229	ENEVELOPE_1	24
	ENEVELOPE_2	
	ENEVELOPE_3	

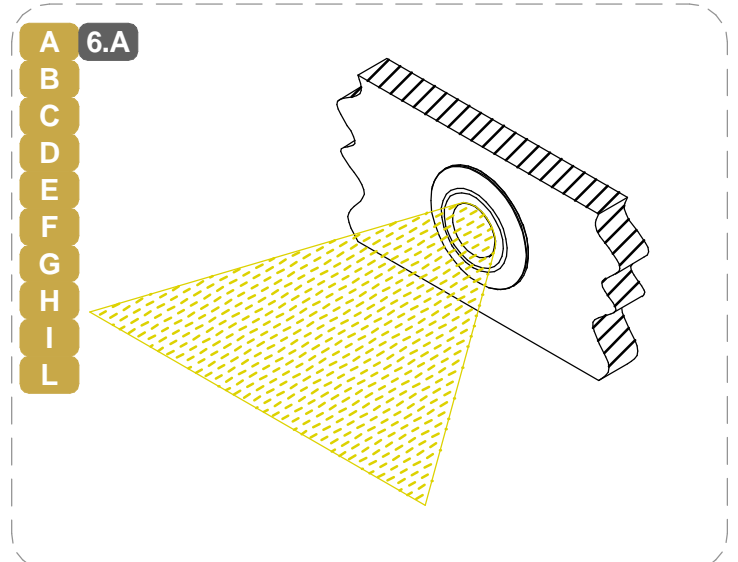
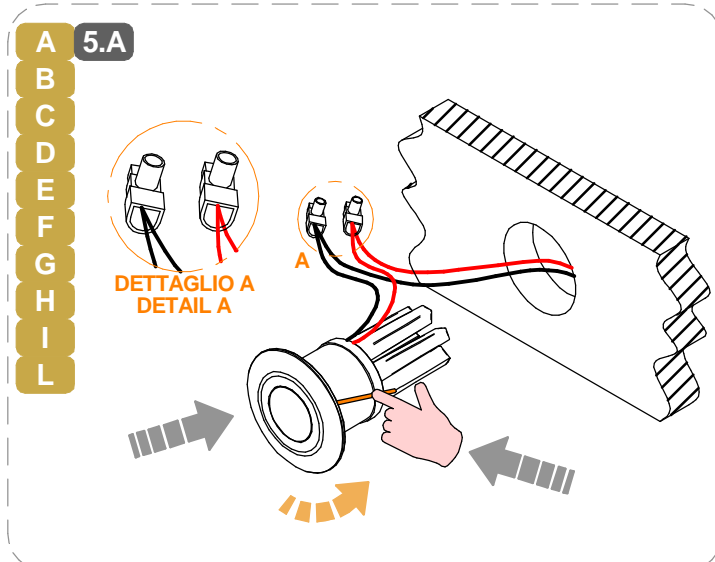
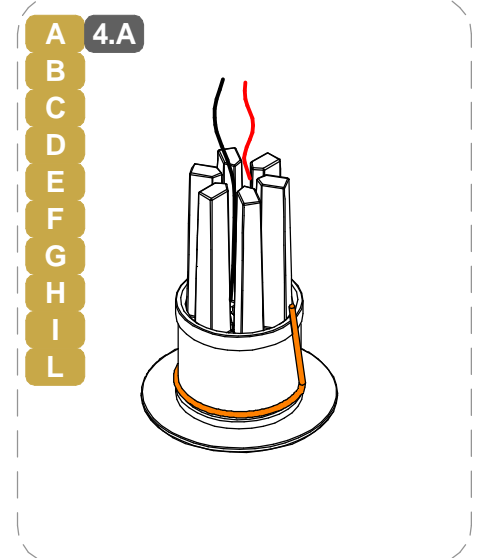
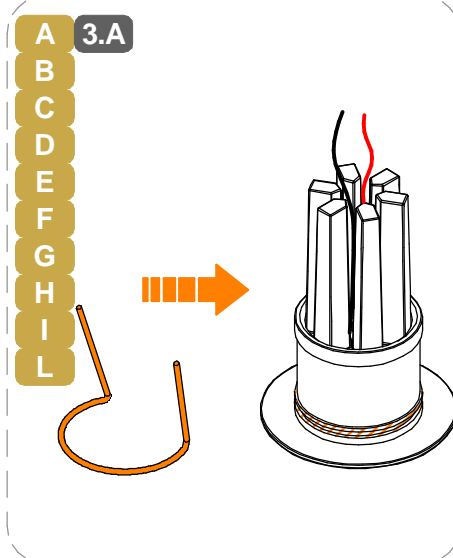
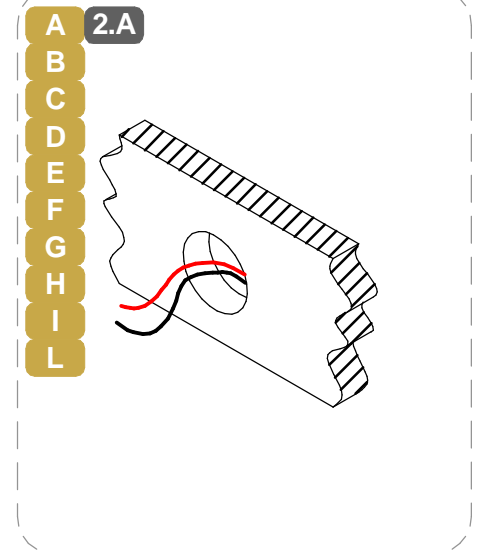
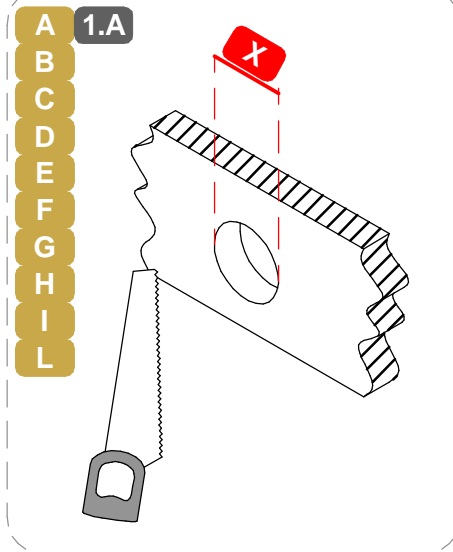

SERIES: ASPHO, BERIEL, ELIN, GUDE, ILAMT, NITUM, TURE, ENVELOPE

BRAND: i-LèD

ACCESSORI NON INCLUSI / NOT INCLUDED ACCESSORIES

Suitable for: Aspho_R 0,5W /
Aspho_R 1W /
Aspho_R 1,5W(RGB) /
Aspho_Q 1W

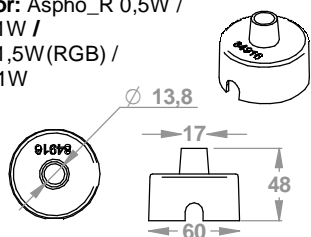

84916

Suitable for: Aspho_R 0,5W /
Aspho_R 1W / Aspho_Q 1W /
Beriel_1W / Elin_0,5W M /
Elin_1w

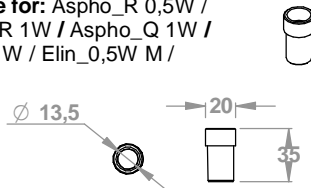

84335

Suitable for: Aspho_R 1,5W /
Aspho_Q 1,5W / Beriel_1,5W /
Elin_1,5W / Ture_1,5W Ø21mm /
Gude_1,5W L.20mm

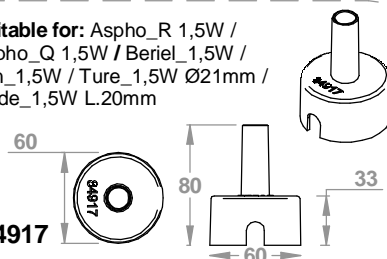

84917

Suitable for: Nitum_R 1W
Nitum_Q 1W

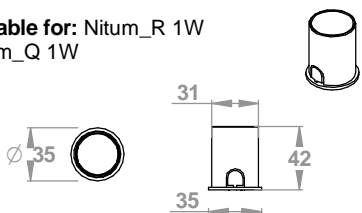

84336

Suitable for: Nitum_R 1W
Nitum_Q 1W

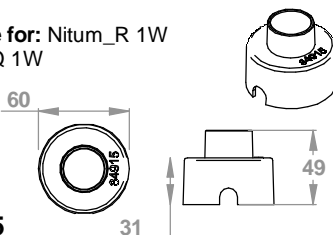

84915

Suitable for: Nitum_R 2W
Nitum_R 2,1W / Nitum_Q 2W
Nitum_Q 2,1W / Elin_0,5W /
Elin_1W / Ture_1,5W Ø41mm /
Gude_1,5W L40mm

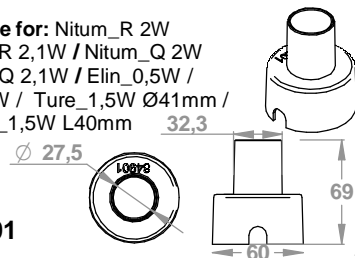

84901

Suitable for: Ture_1,5W Ø31mm
/ Gude_1,5W_L30mm

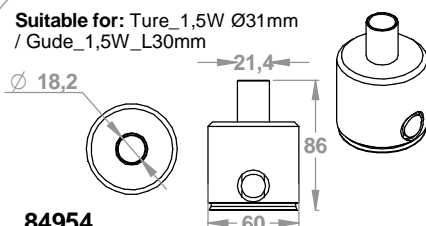

84954

Suitable for: Ilamt_1W 22mm

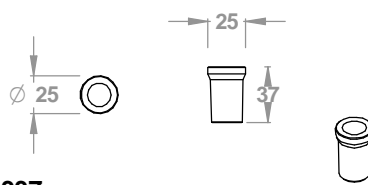

84337

Suitable for: Ilamt_2W /
Ilamt66 2W 30mm

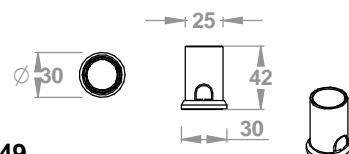

84349

Suitable for: Envelope_1 /
Envelope_2 / Envelope_4

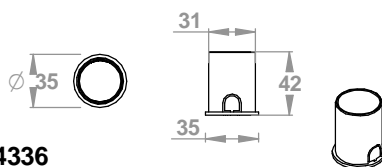

84336

INSTALLAZIONE SU MURATURA O CALCESTRUZZO / CONCRETE OR BRICKWORK INSTALLATION

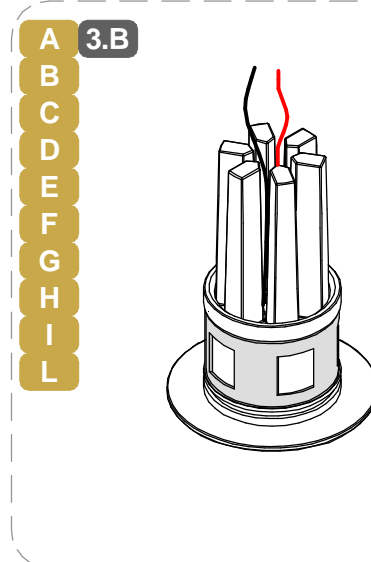
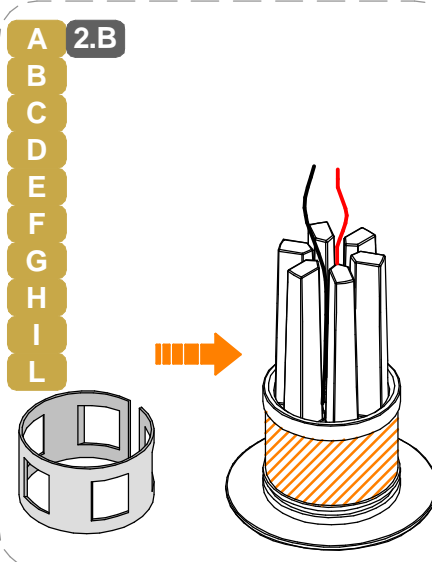
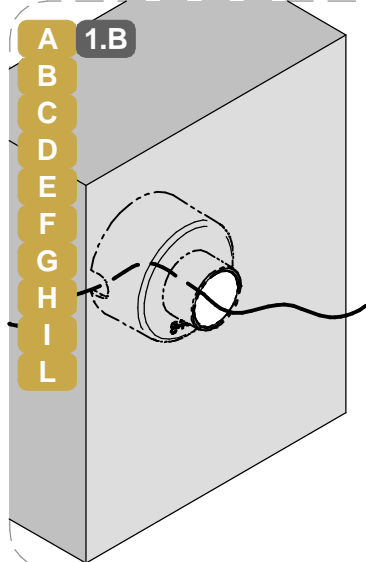

SERIES: ASPHO, BERIEL, ELIN, GUDE, ILAMT, NITUM, TURE, ENVELOPE

BRAND: i-L^{ED}

MARRONE / BROWN = LINEA / LINE

AZZURRO / LIGHT BLUE = NEUTRO / NEUTRAL

GIALLO-VERDE / YELLOW-GREEN = TERRA / EARTH CPC | PE

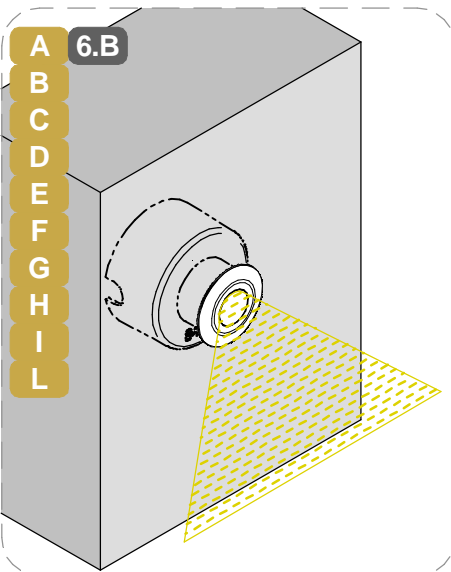
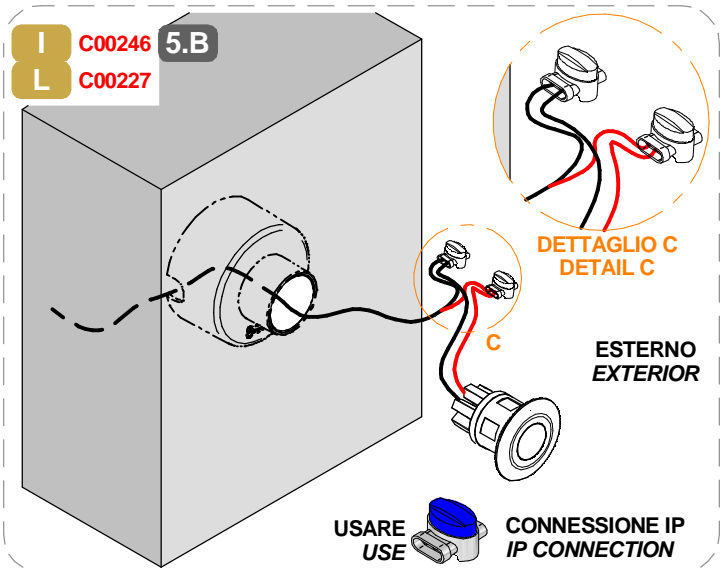
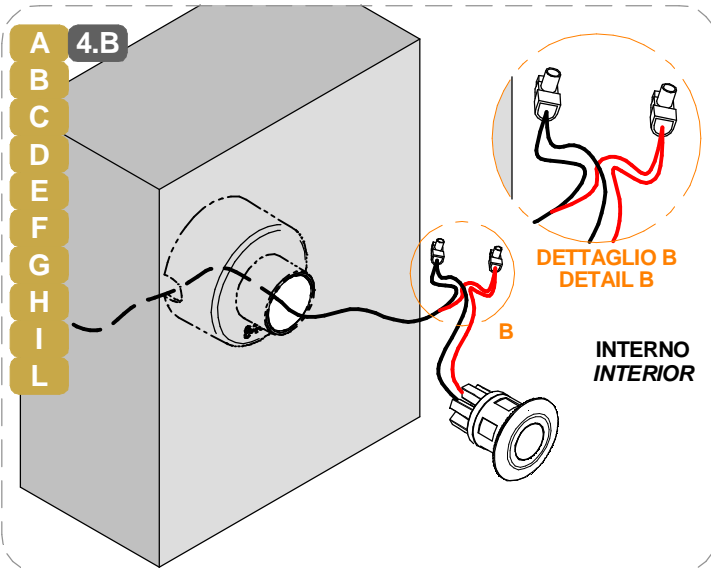

⚠

**LAVARE LA SUPERFICIE DEL
DIFFUSORE LUCE
CON PANNO UMIDO, UTILIZZANDO
SOLO ACQUA
E SAPONE NEUTRO.**

**CLEAN THE SURFACE OF THE LIGHT
DIFFUSER
WITH A DAMP CLOTH, USING ONLY
WATER
AND NEUTRAL SOAP**

CABLAGGIO / WIRING

1 TUTTE LE OPERAZIONI DI COLLEGAMENTO ALLA RETE ELETTRICA DEVONO ESSERE CONDOTTE IN MANCANZA DI TENSIONE

ALL THE WIRING OPERATION MUST BE PERFORMED WITH MCB IN OFF POSITION

2 SE IL PRODOTTO E' DEFINITO IN CLASSE 1, IL CONDUTTORE DI MESSA A TERRA DI PROTEZIONE DEVE ESSERE SEMPRE COLLEGATO

IF THE FITTING IS CLASS 1 RATED, THE CPC | EARTH | PE CONDUCTOR MUST BE CONNECTED

3 SE L'IMPIANTO E' STATO COMPLETATO ED E' IN SICUREZZA, PUO' ESSERE ALIMENTATO

WHEN THE CIRCUIT IS COMPLETED AND SAFE, MCB CAN BE SET IN ON POSITION

⚠

SE IL PRODOTTO E' DEFINITO IN CLASSE 3, IL CIRCUITO SECONDARIO A BASSA TENSIONE DEVE ESSERE COLLEGATO ALL'ALIMENTATORE PRIMA CHE QUESTO SIA SOTTO TENSIONE

IF THE FITTING IS CLASS 3 RATED, THE LOW VOLTAGE CIRCUIT MUST BE WIRED BEFORE THE POWER SUPPLY IS POWERED ON

SE IL CARICO VENISSE COLLEGATO AD ALIMENTATORE SOTTO TENSIONE, I PRODOTTI POTREBBERO DANNEGGIARSI, SUBENDO UN DANNO DA SOVRATENSIONE

IF THE LOAD IS WIRED TO AN ALREADY ON POWER SUPPLY, THE FITTINGS COULD BE DAMAGED BY VOLTAGE SURGE

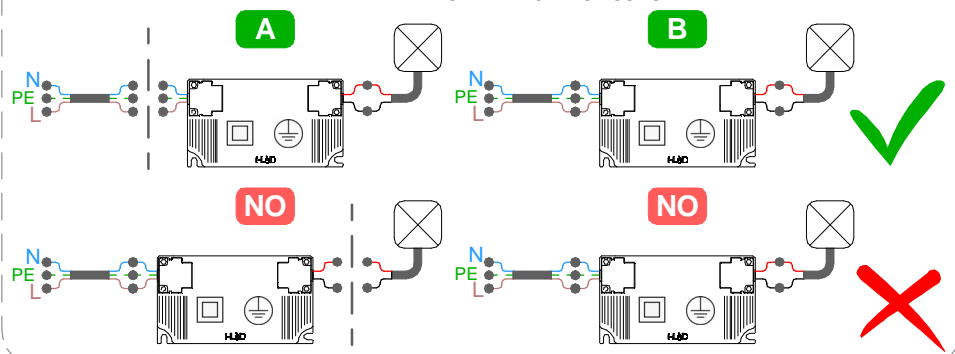

**TIPO DI CONNESSIONE
TYPE OF CONNECTION**

X: Se il cavo flessibile esterno di questo apparecchio è danneggiato, deve essere sostituito da un cavo speciale, disponibile esclusivamente presso il fabbricante, o il suo servizio di assistenza.

X: If the external flexible cable of this appliance is damaged, it must be replaced with a special cable, which is only available from the manufacturer or its service department.

Y: Se il cavo flessibile esterno di questo apparecchio è danneggiato, deve essere sostituito esclusivamente dal fabbricante, dal suo servizio di assistenza o da personale qualificato equivalente, al fine di evitare pericoli.

Y: If the external flexible cable of this appliance is damaged, it must only be replaced by the manufacturer, its service department or equivalent qualified personell in order to avoid danger.

Z: Il cavo flessibile esterno di questo apparecchio non può essere sostituito; se il cavo è danneggiato l'apparecchio deve essere distrutto.

Z: The external flexible cable fo this appliance cannot be replaced; if the cable is damaged, the appliance must be destroyed.

SERIES: ASPHO, BERIEL, ELIN, GUDE, ILAMT, NITUM, TURE, ENVELOPE

BRAND: i-LèD

MARRONE / BROWN = LINEA / LINE

AZZURRO / LIGHT BLUE = NEUTRO / NEUTRAL

GIALLO-VERDE / YELLOW-GREEN = TERRA / EARTH CPC | PE

CABLAGGIO IN PARALLELO | TENSIONE COSTANTE
PARALLEL WIRING | CONSTANT VOLTAGE

CV

N° MAX
DEVICES

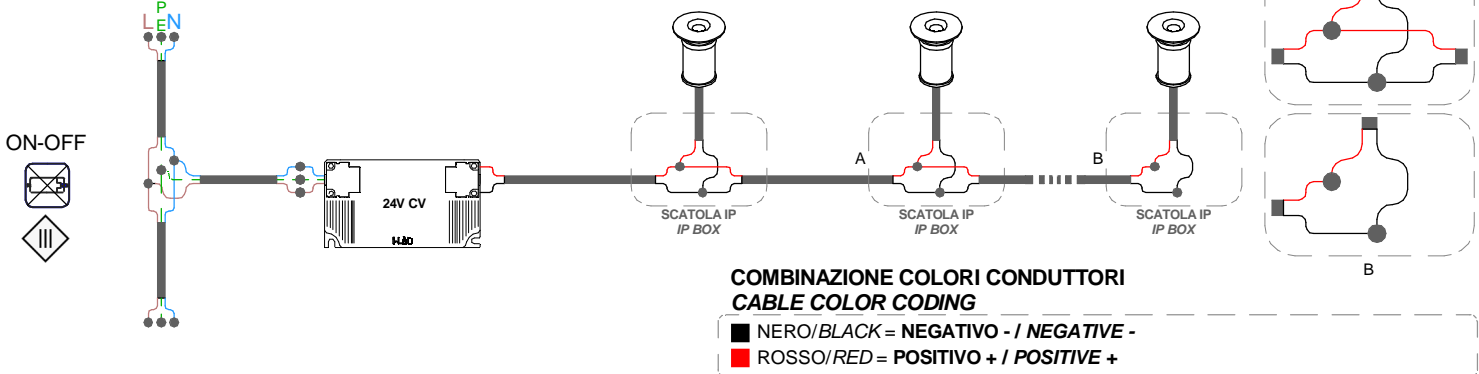

CABLAGGIO IN SERIE | CORRENTE COSTANTE
SERIES WIRING | CONSTANT CURRENT

CV

N° MAX
DEVICES

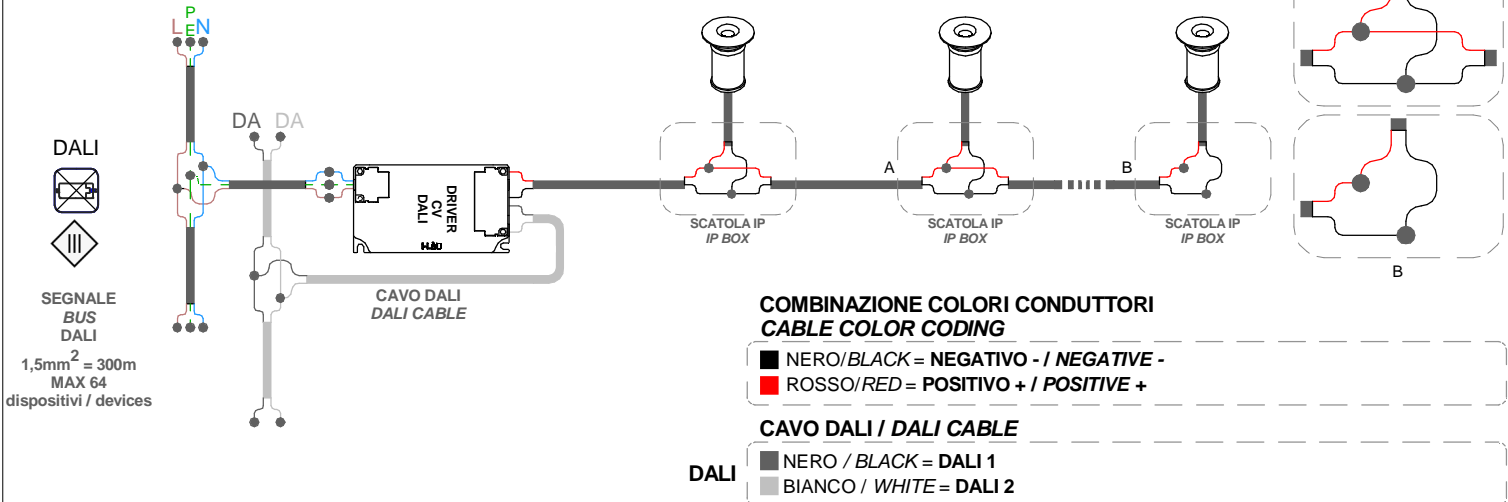

CABLAGGIO IN SERIE | CORRENTE COSTANTE
SERIES WIRING | CONSTANT CURRENT

CV

N° MAX
DEVICES

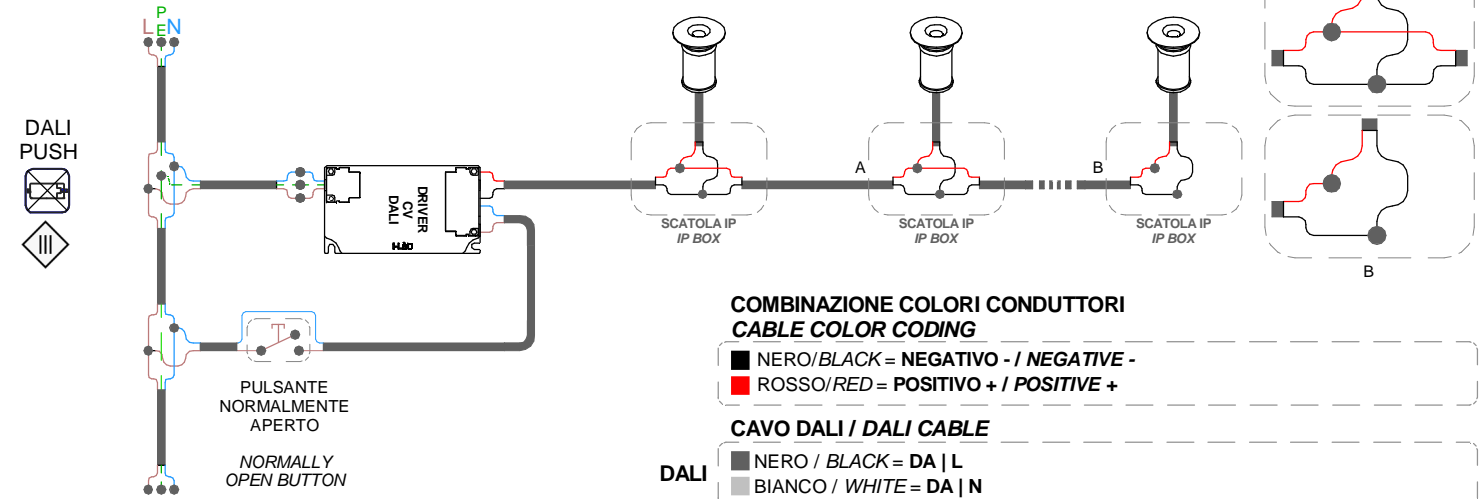

SERIES: ASPHO, BERIEL, ELIN, GUDE, ILAMT, NITUM, TURE, ENVELOPE

BRAND: i-L^{ED}

MARRONE / BROWN = LINEA / LINE

AZZURRO / LIGHT BLUE = NEUTRO / NEUTRAL

GIALLO-VERDE / YELLOW-GREEN = TERRA / EARTH CPC | PE

RGB
CENTRALINA SMART
SMART CONTROLLER
CABLAGGIO IN PARALLELO
PARALLEL WIRING

CV

N° MAX
DEVICES

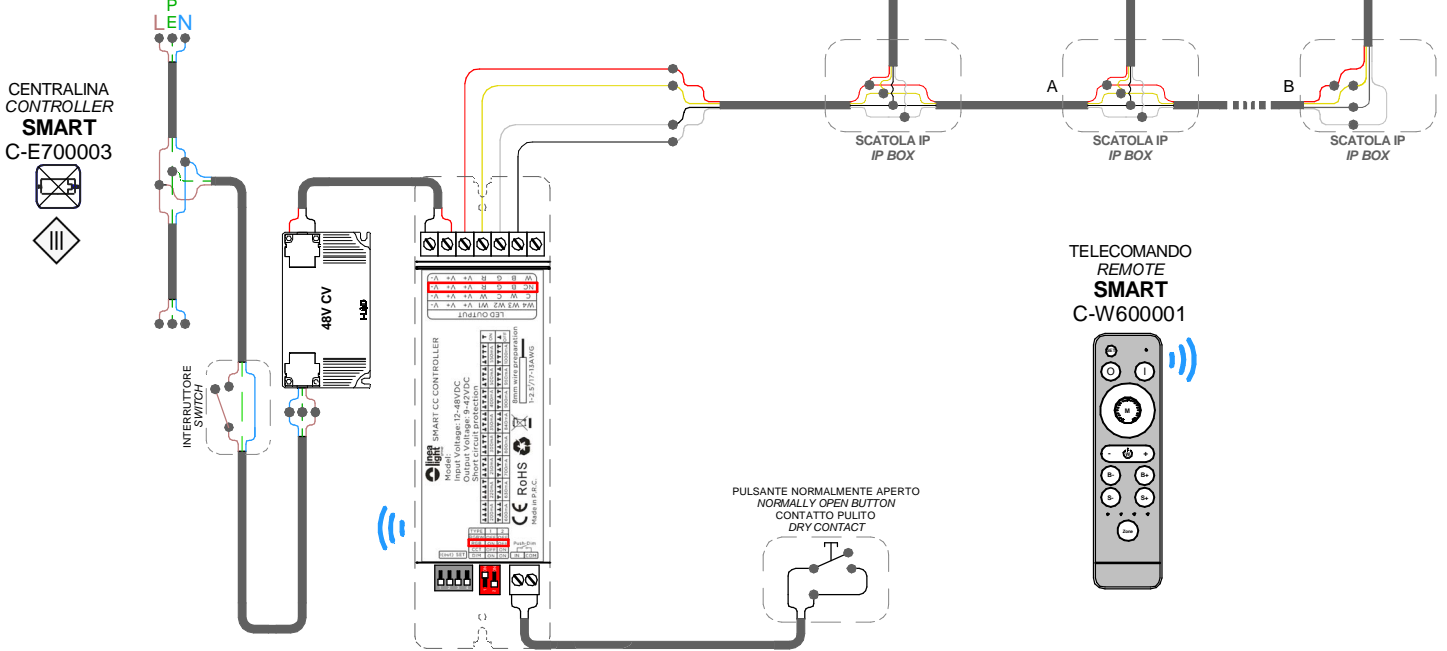

CABLAGGIO IN SERIE | CORRENTE COSTANTE
SERIES WIRING | CONSTANT CURRENT

CC

N° MAX
DEVICES

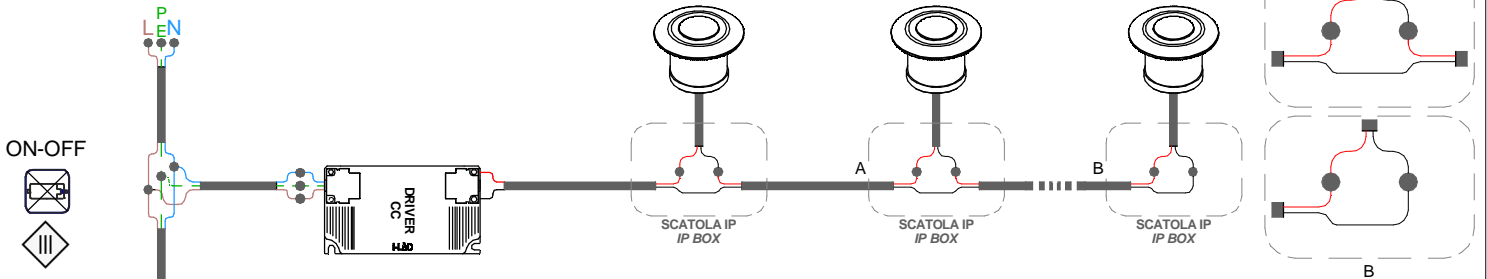

COMBINAZIONE COLORI CONDUTTORI
CABLE COLOR CODING

- NERO/BLACK = NEGATIVO - / NEGATIVE -
- ROSSO/RED = POSITIVO + / POSITIVE +

CABLAGGIO IN SERIE | CORRENTE COSTANTE
SERIES WIRING | CONSTANT CURRENT

CC

N° MAX
DEVICES

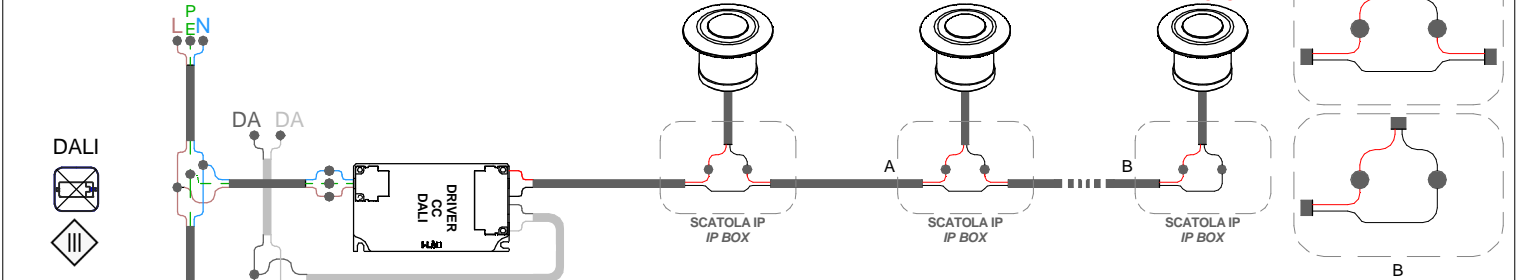

COMBINAZIONE COLORI CONDUTTORI
CABLE COLOR CODING

- NERO/BLACK = NEGATIVO - / NEGATIVE -
- ROSSO/RED = POSITIVO + / POSITIVE +

CAVO DALI / DALI CABLE

- NERO / BLACK = DALI 1
- BIANCO / WHITE = DALI 2

SERIES: ASPHO, BERIEL, ELIN, GUDE, ILAMT, NITUM, TURE, ENVELOPE

BRAND: i-L^{ED}

MARRONE / BROWN = LINEA / LINE

AZZURRO / LIGHT BLUE = NEUTRO / NEUTRAL

GIALLO-VERDE / YELLOW-GREEN = TERRA / EARTH CPC | PE

CABLAGGIO IN SERIE | CORRENTE COSTANTE
SERIES WIRING | CONSTANT CURRENT

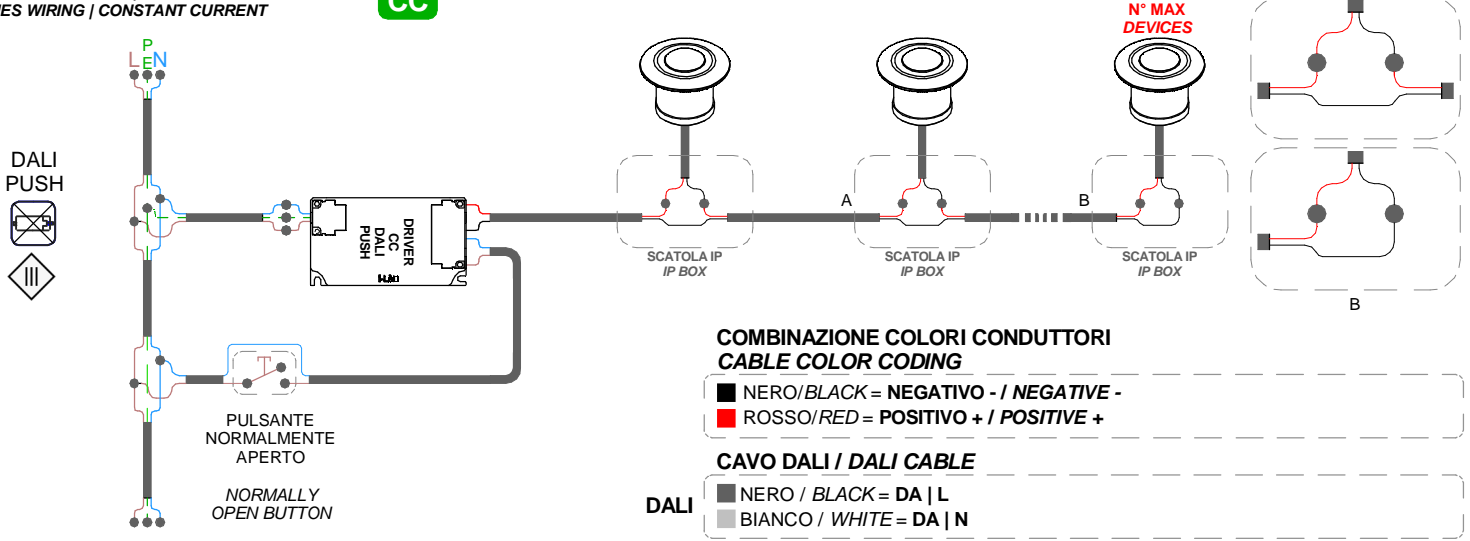

RGB | NITUM
CENTRALINA SMART
SMART CONTROLLER
CABLAGGIO IN
SERIE |
CORRENTE
COSTANTE
SERIES WIRING |
CONSTANT
CURRENT

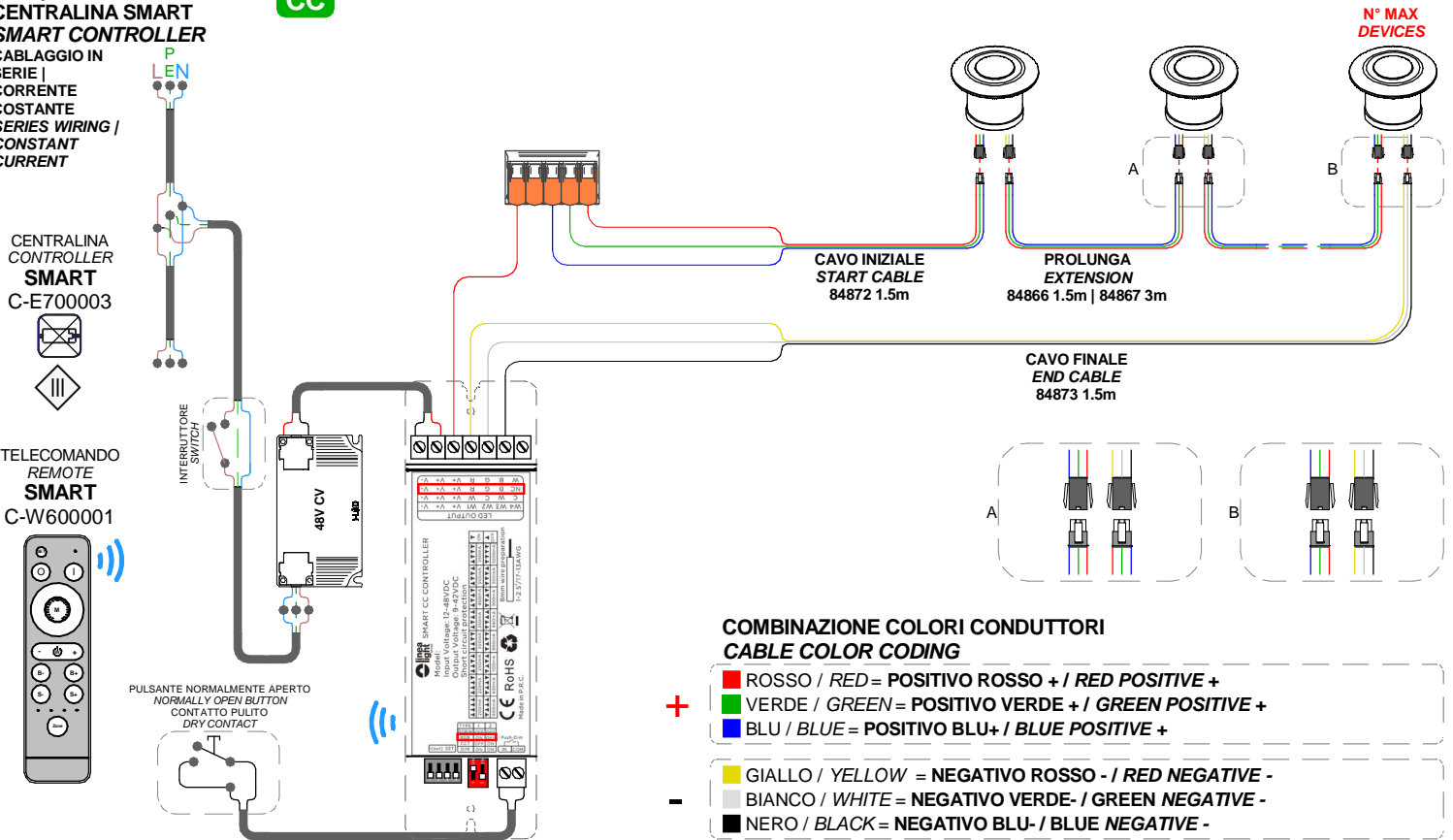

SERIES: ASPHO, BERIEL, ELIN, GUDE, ILAMT, NITUM, TURE, ENVELOPE
BRAND: i-LÉD
**N° MAX
DEVICES**
**N° DI
PRODOTTI
PER ALIMENTATORE**
**N° OF LIGHT
FITTINGS
PER DRIVER**

TIPO TYPE	CC CV		ON-OFF										
	CODE	C.C C.V.	99195	89147	99376	99105	89144	89145	89146	99375	99377	89408	99374
88417	C.V.											1-10	1-135
85001	C.V.											1-10	1-135
85002	C.V.											1-10	1-135
91352 *	C.V.												
86707 *	C.V.												
86708 *	C.V.												
C00263	C.C						1-2	3-6		6-12			
C00264	C.C	1-2							2-3	3-6			
C00267	C.C					1-2	3-6			6-12			
C00268	C.C	1-2							2-3	3-6			
C00269	C.C						1-2	3-6		6-12			
C00273	C.C		1-2	3-6	6-12								
88568 *	C.C												
86612 *	C.C												
86613 *	C.C												
86674 *	C.C												
C00275	C.C						1-2	3-6		6-12			
C00276	C.C		1-2	3-6	6-12								
88569 *	C.C												
86614 *	C.C												
86615 *	C.C												
86675 *	C.C												
C00283	C.C						1-2	3-6		6-12			
C00284	C.C	1-2							2-3	3-6			
87340 *	C.V.												
C00292	C.C						1-2	3-6		6-12			
C00293	C.C	1-2							2-3	3-6			
C00294	C.C	1-2							2-3	3-6			
C00295	C.C	1-2							2-3	3-6			
C00296	C.C	1-2							2-3	3-6			
C00297	C.C	1-2							2-3	3-6			
C00298	C.C	1-2							2-3	3-6			
C00299	C.C	1-2							2-3	3-6			
C00244	C.C						1-2	3-6		6-12			
C00245	C.C		1-2	3-6	6-12								
C00246	C.C		1-2	3-6	6-12								
C00227	C.C						1-2	3-6		6-12			
C00228	C.C						1-2	3-6		6-12			
C00229	C.C						1-2	3-6		6-12			

***RGB**

TIPO TYPE	CC CV		0/1-10V + 24V CV				DALI	DALI + 24V CV	DALI2 PUSH		SMART CONTROL + 99331 24V CV	SMART CONTROL + 99784 48 CV	DMX + 99331 24V CV	DMX + 99331 48V CV	
	CODE	C.C C.V.	99710	99332	C-E100010	C-E100004	99722	99713	83333	C-E100011	C-E100005	C-E700002 C-W600001	C-E700002 C-W600001	C-E700002	C-E700002
88417	C.V.			1-270			1-220								
85001	C.V.			1-270			1-220								
85002	C.V.			1-270			1-220								
91352 *	C.V.							1-270			1-140		1-140		
86707 *	C.V.							1-270			1-140		1-140		
86708 *	C.V.							1-270			1-140		1-140		
C00263	C.C			3-4		3-4			3-4						
C00264	C.C				3-4					3-4					
C00267	C.C			3-4		3-4			3-4						
C00268	C.C				3-4					3-4					
C00269	C.C			3-4		3-4			3-4						
C00273	C.C	1-6					1-6								
88568 *	C.C											6-12		6-12	
86612 *	C.C											6-12		6-12	
86613 *	C.C											6-12		6-12	
86674 *	C.C											6-12		6-12	
C00275	C.C			3-4		3-4			3-4						
C00276	C.C	1-6					1-6								
88569 *	C.C											6-12		6-12	
86614 *	C.C											6-12		6-12	
86615 *	C.C											6-12		6-12	
86675 *	C.C											6-12		6-12	
C00283	C.C			3-4		3-4			3-4						
C00284	C.C				3-4					3-4					
87340 *	C.V.											6-12		6-12	
C00292	C.C			3-4		3-4			3-4						
C00293	C.C				3-4					3-4					
C00294	C.C				3-4					3-4					
C00295	C.C				3-4					3-4					
C00296	C.C				3-4					3-4					
C00297	C.C				3-4					3-4					
C00298	C.C				3-4					3-4					
C00299	C.C				3-4					3-4					
C00244	C.C			3-4		3-4			3-4						
C00245	C.C	1-6					1-6								
C00246	C.C	1-6					1-6								
C00227	C.C			3-4		3-4			3-4						
C00228	C.C			3-4		3-4			3-4						
C00229	C.C			3-4		3-4			3-4						

***RGB**

PER ULTERIORI
INFORMAZIONI SUL
COLLEGAMENTO CON
CONTROLLER DMX O
DALI DT8
CONTATTARE

support@linealight.com

FOR FURTHER
INFORMATION ON
CONNECTION TO A DMX
OR DALI DT8
CONTROLLER, PLEASE
CONTACT

support@linealight.com