

SMALL

3000 K

2700 K

<input type="checkbox"/> CA086DWHWDI	<input type="checkbox"/> CA086DWHMDI
<input type="checkbox"/> CA086DBBWDI	<input type="checkbox"/> CA086DBBMDI
<input type="checkbox"/> CA086DBEWDI	<input type="checkbox"/> CA086DBEMDI
<input type="checkbox"/> CA086DGBWDI	<input type="checkbox"/> CA086DGBMDI
<input type="checkbox"/> CA086DLUWDI	<input type="checkbox"/> CA086DLUMDI

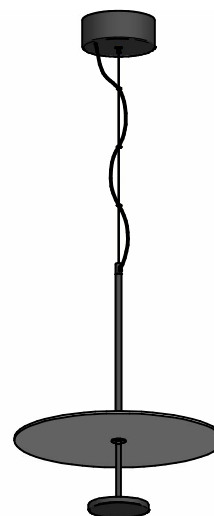

MEDIUM

3000 K

2700 K

<input type="checkbox"/> CA087DWHWDI	<input type="checkbox"/> CA087DWHMDI
<input type="checkbox"/> CA087DBBWDI	<input type="checkbox"/> CA087DBBMDI
<input type="checkbox"/> CA087DBEWDI	<input type="checkbox"/> CA087DBEMDI
<input type="checkbox"/> CA087DGBWDI	<input type="checkbox"/> CA087DGBMDI
<input type="checkbox"/> CA087DLUWDI	<input type="checkbox"/> CA087DLUMDI

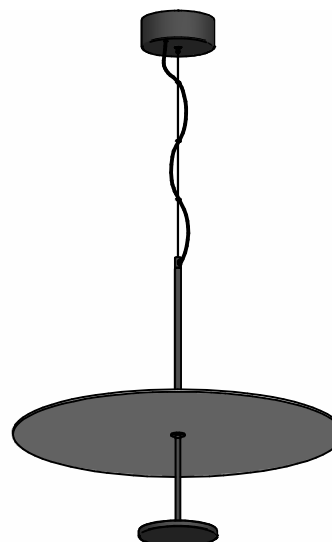

LARGE

3000 K

2700 K

<input type="checkbox"/> CA088DWHWDI	<input type="checkbox"/> CA088DWHMDI
<input type="checkbox"/> CA088DBBWDI	<input type="checkbox"/> CA088DBBMDI
<input type="checkbox"/> CA088DBEWDI	<input type="checkbox"/> CA088DBEMDI
<input type="checkbox"/> CA088DGBWDI	<input type="checkbox"/> CA088DGBMDI
<input type="checkbox"/> CA088DLUWDI	<input type="checkbox"/> CA088DLUMDI

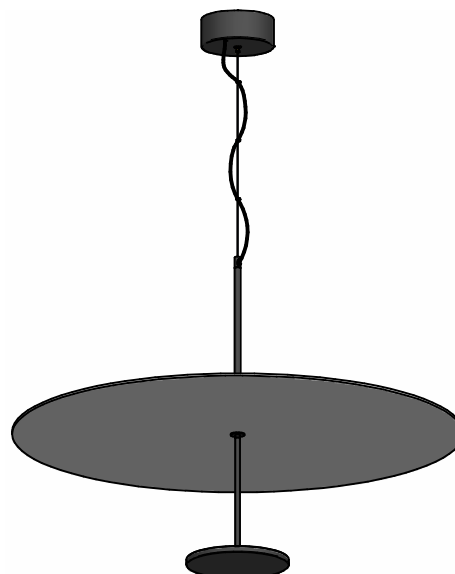

1

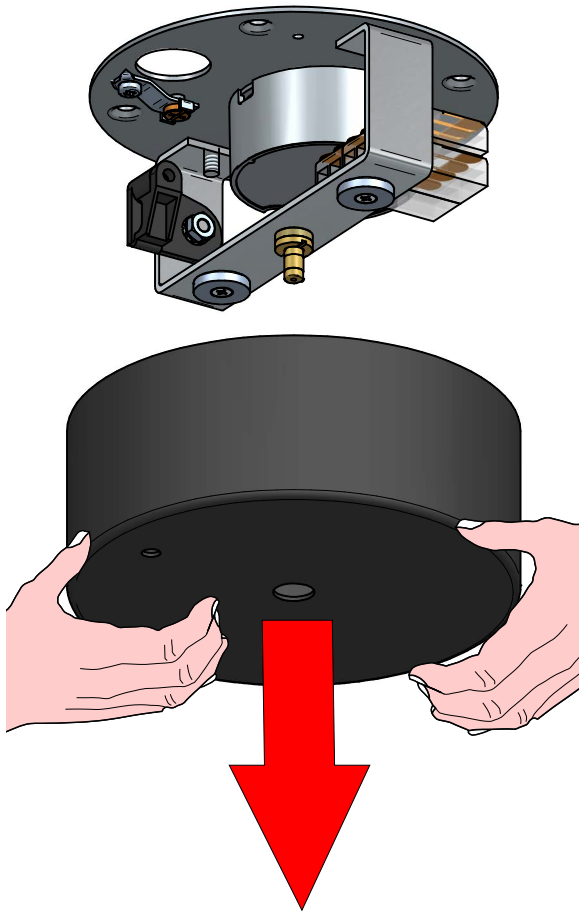

2

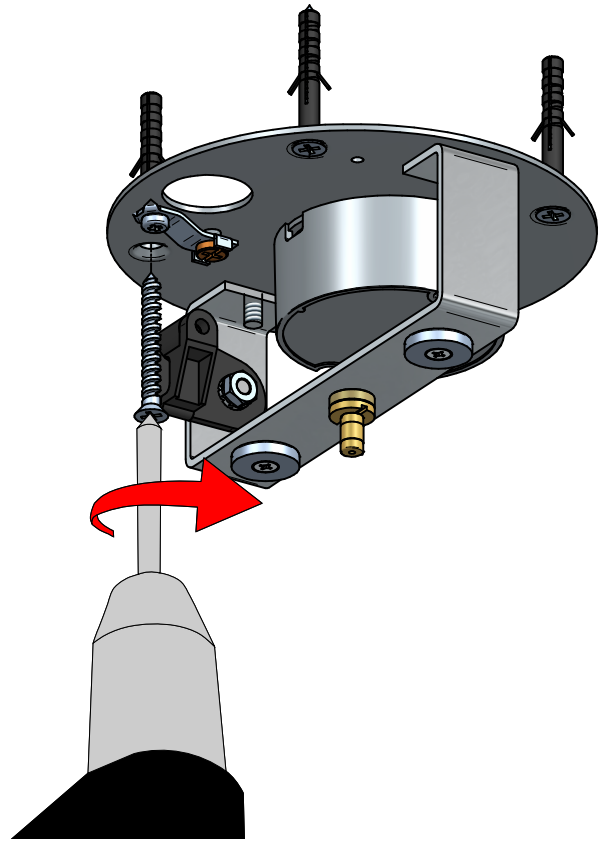

3

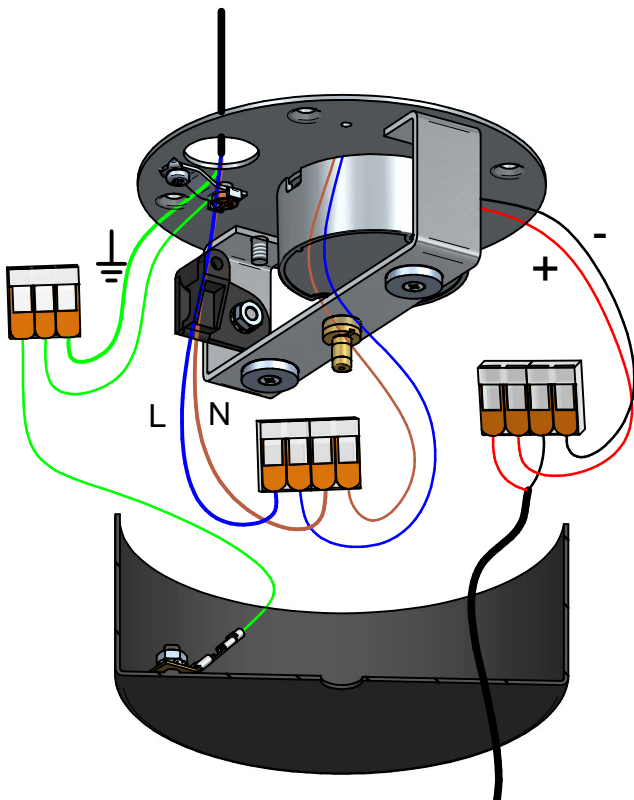

4

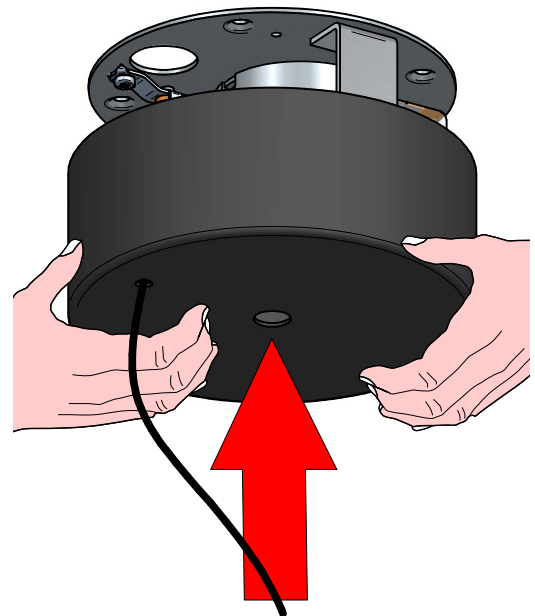

5

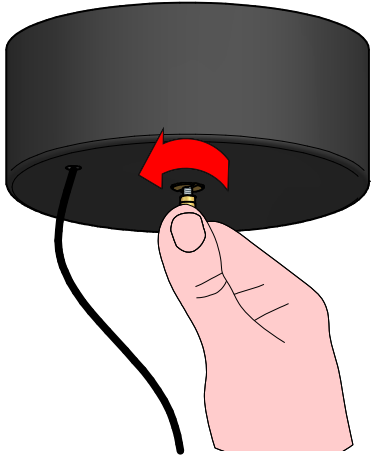

6

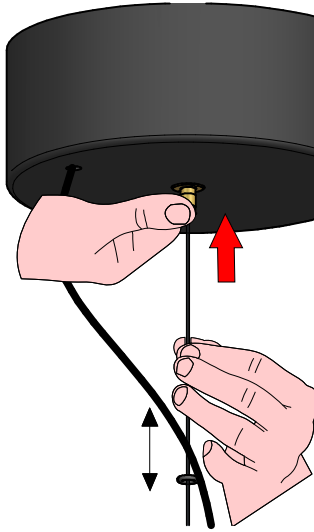

7

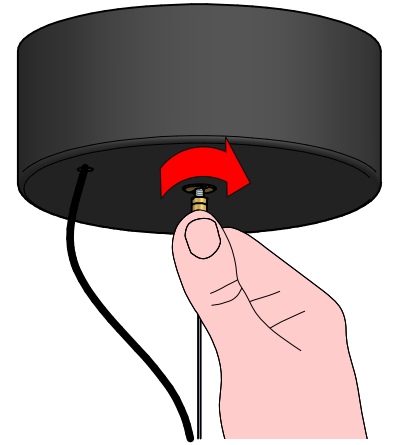

8

