

# DROP 7

*Arihiro Miyake*

Instinct and constant design diligence in a collection that is the outcome of a sophisticated lighting engineering. A clear lines chandelier combined with an extremely slim aluminium structure for a soft echo of strong and diffused light. Each profile and connector is linked through a miniaturised connection for a unique result of suspended lightness.



2700K

### LAMPING

Source	linear LED
Total power	60W
Emission	diffused
Switching	1-10V
Tension	110-230V
Color temperature	2700K
Luminous flux	5700lm (nominal flux)
Typ CRI	90
Dimensions	ø90x50
Notes	total height 50cm, cable length 2,5m, TRIAC VERSION on request
Net lamp weight	1,5kg kg

### Codes

DRP LNN 52  
DRP LDD 52  
DRP LGG 52

### Structure

black  
silver  
gold

### PACKAGE

Package 01

Dimension: 110X110X60 cm

### Certificazioni

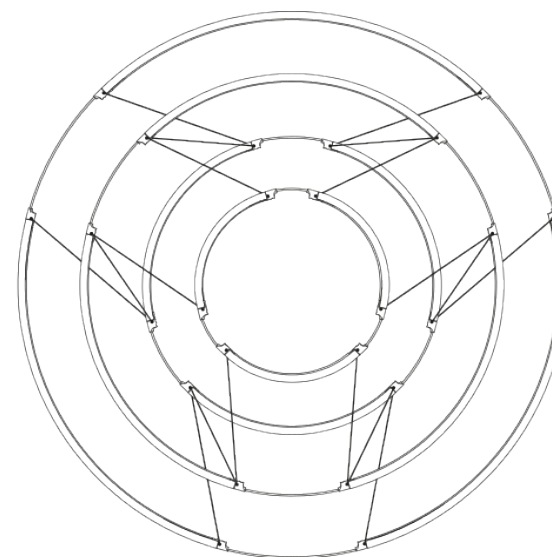

90

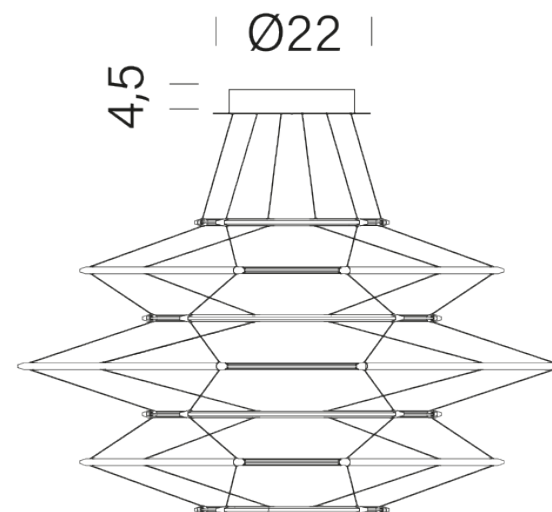

4,5

Ø22

50±2