

2097/18

Designed by Gino Sarfatti, 1958

A1352031

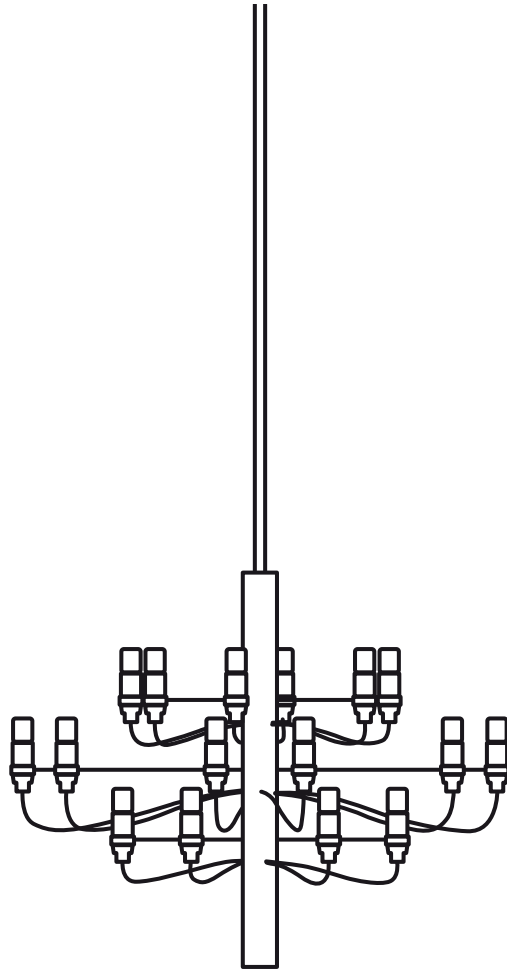

2097/18

A1352031

EN

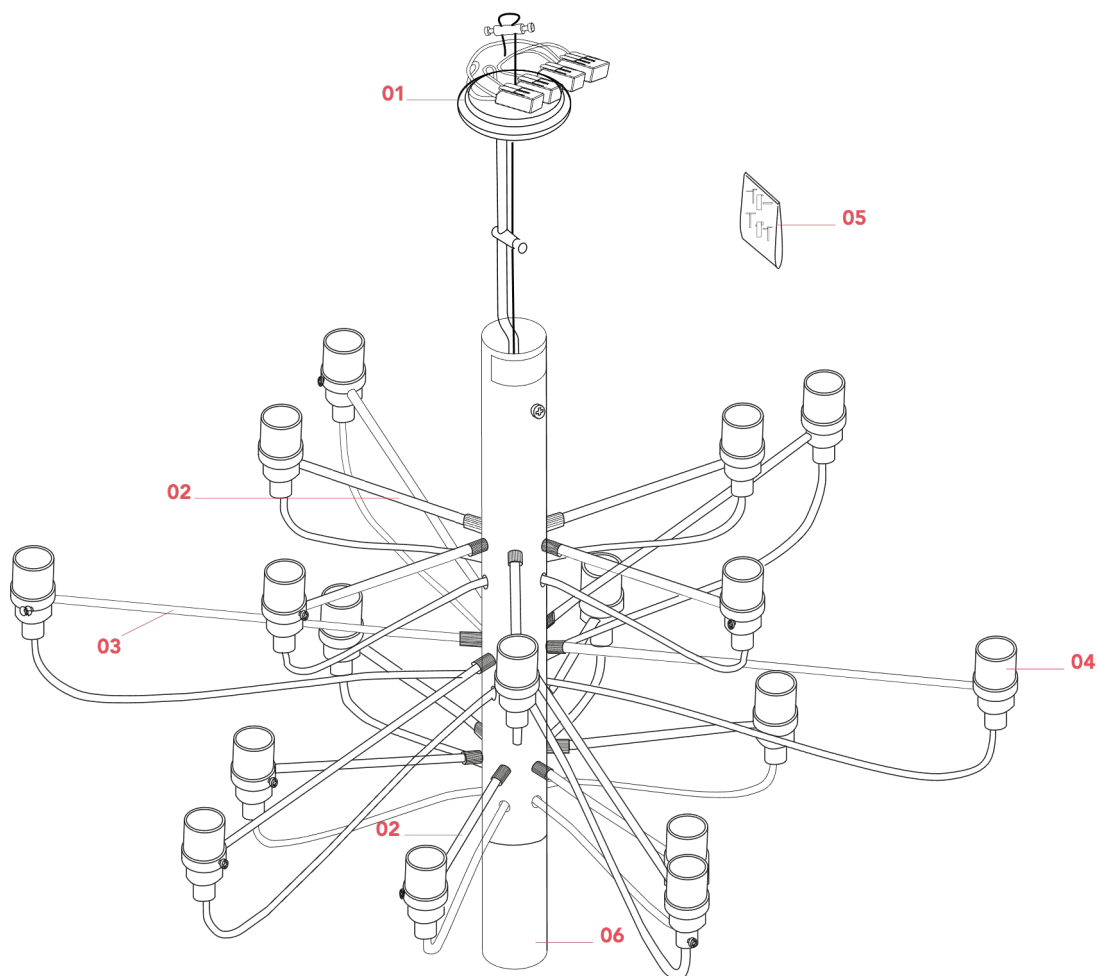

- 01. RL7060800 – Ceiling rose
- 02. RF26022 – Opal black short arm (200mm)
- 03. RF33864 – Opal black medium arm (310mm)
- 04. RL7050100 – 2097 E14 lamp holder
- 05. RF1400100 – 2097 opal black screw kit
- 06. RF1400200 – Opal black lower cap

2097/18 A1352031

EN

RL7060800

CEILING ROSE

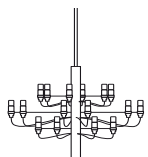

2097/18
p.3

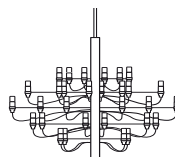

2097/30
p.3

WARNING! When installing and whenever acting on the appliance, ensure that the power supply has been switched off.
For the installation of the spare-part, it is necessary to consult a qualified electrician.

2097/18 A1352031

EN

RL7060800

CEILING ROSE

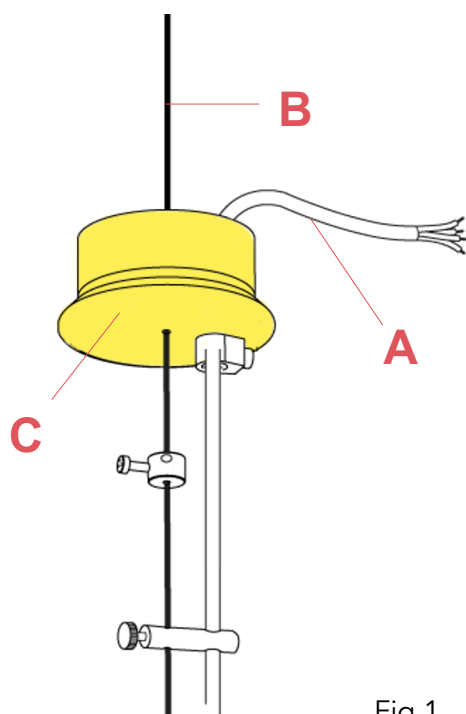

Fig.1

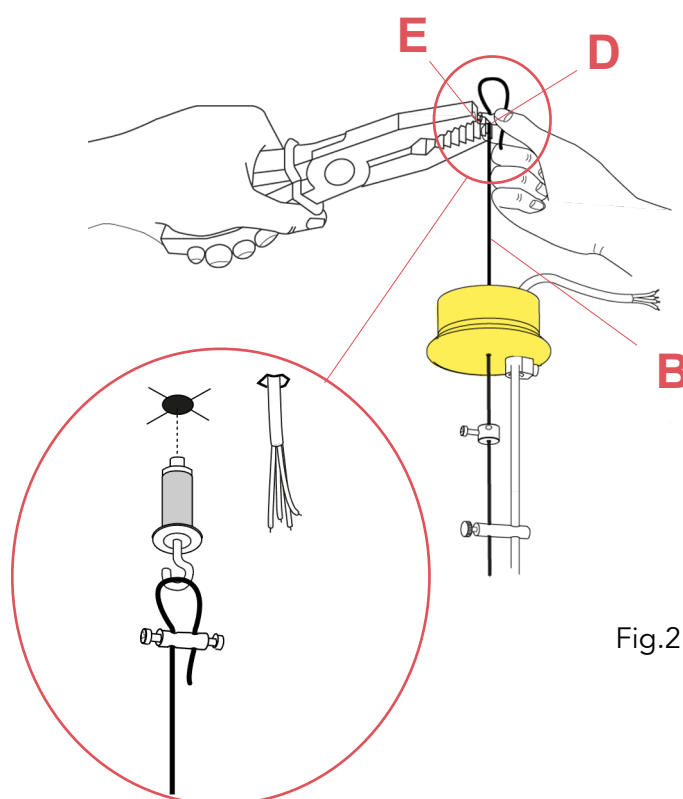

Fig.2

Insert the power supply cable (A) and the steel wire (C) through the ceiling rose (C).
Adjust and then cut the steel wire (B) to the length desired.
Insert the steel wire (B) through the clamp (D) so as to form a loop. Tighten screw (E).

WARNING! When installing and whenever acting on the appliance, ensure that the power supply has been switched off.
For the installation of the spare-part, it is necessary to consult a qualified electrician.

2097/18 A1352031

EN

RL7060800

CEILING ROSE

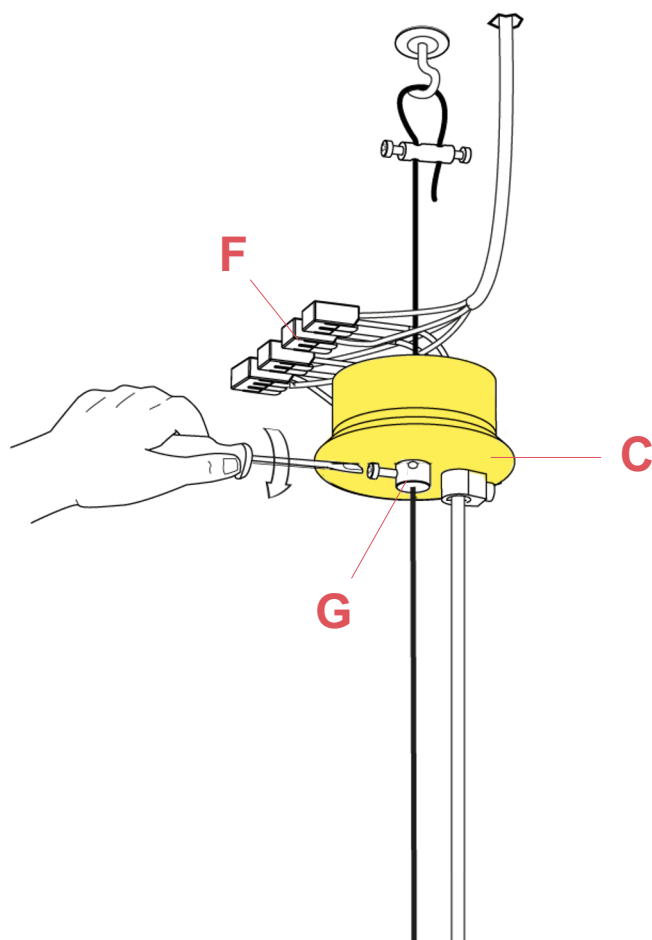

Fig.3

Connect the power supply cord to the terminal block (F).
The apparatus has been designed for double wall switch:
Neutral wire = BLUE.

1st phase wire for 1st wall switch = BROWN.

2nd phase 2nd wall switch = BLACK.

If you choose to utilize only on single wall switch it is necessary to bridge the brown wire with the black wire.

Push the ceiling rose (C) into position and lock it through the cable clamp (G).

WARNING! When installing and whenever acting on the appliance, ensure that the power supply has been switched off.
For the installation of the spare-part, it is necessary to consult a qualified electrician.

2097/18 A1352031

EN

RF26022

OPAL BLACK SHORT ARM (200mm)

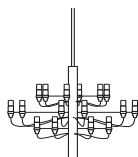

2097/18
p.6

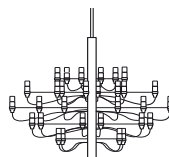

2097/50
p.6

WARNING! When installing and whenever acting on the appliance, ensure that the power supply has been switched off.
For the installation of the spare-part, it is necessary to consult a qualified electrician.

2097/18 A1352031

EN

RF26022

OPAL BLACK SHORT ARM (200mm)

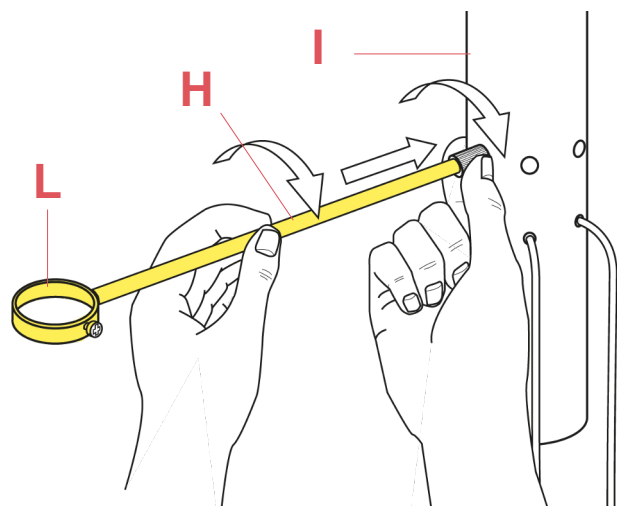

Fig.1

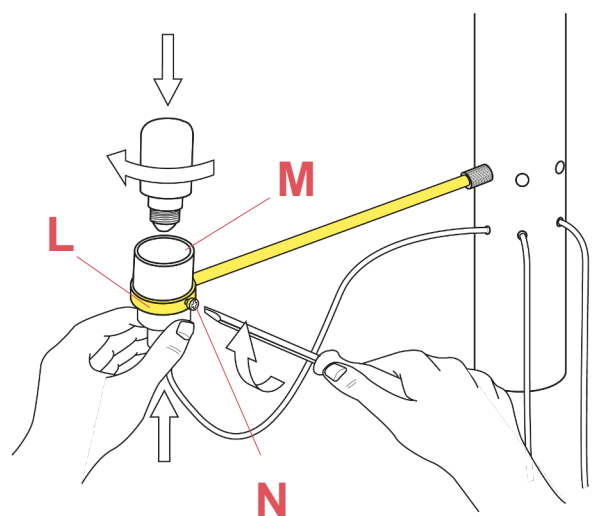

Fig.2

Screw the arms (H) to the lamp body (I), taking care not to bend on the rings (L).
Insert the lamp holder (M) in the ring (L) and fasten them by locking the screw (N).

WARNING! When installing and whenever acting on the appliance, ensure that the power supply has been switched off.
For the installation of the spare-part, it is necessary to consult a qualified electrician.

2097/18 A1352031

EN

RF33864

OPAL BLACK MEDIUM ARM (310mm)



WARNING! When installing and whenever acting on the appliance, ensure that the power supply has been switched off.
For the installation of the spare-part, it is necessary to consult a qualified electrician.

©2021 Flos - All rights reserved - www.flos.com
Flos reserves the right to introduce any changes to its own models, without prior notice.

2097/18 A1352031

EN

RF33864

OPAL BLACK MEDIUM ARM (310mm)

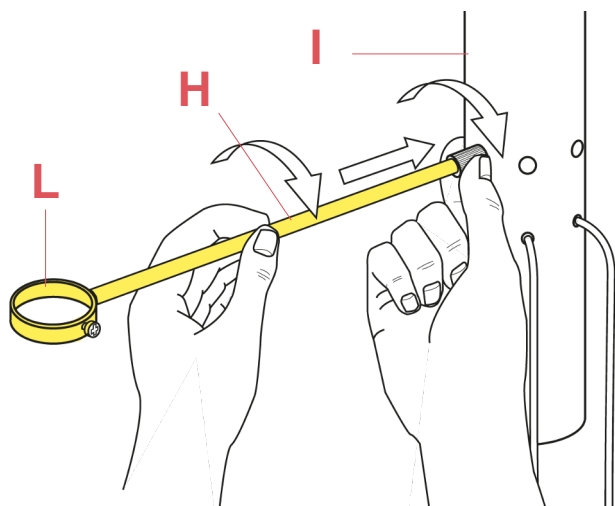

Fig.1

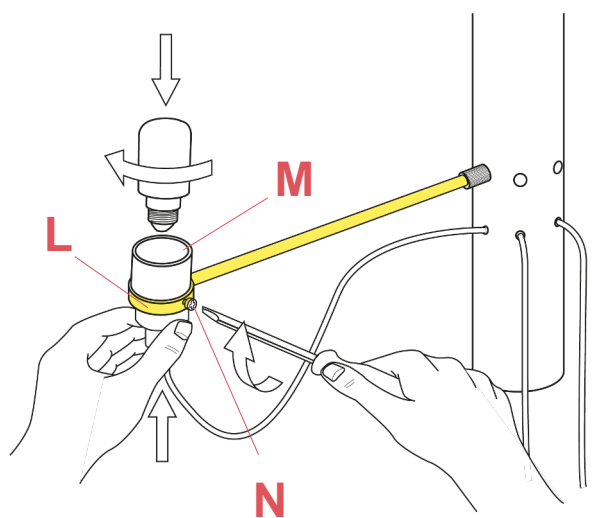

Fig.2

Screw the arms (H) to the lamp body (I), taking care not to bend on the rings (L). Insert the lamp holder (M) in the ring (L) and fasten them by locking the screw (N).

WARNING! When installing and whenever acting on the appliance, ensure that the power supply has been switched off. For the installation of the spare-part, it is necessary to consult a qualified electrician.

2097/18 A1352031

EN

RL7050100

2097 E14 LAMP HOLDER

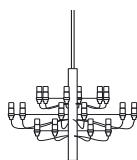

2097/18
p.10

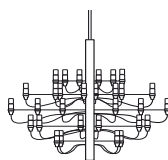

2097/30
p.12

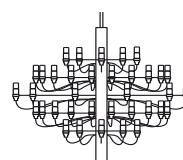

2097/50
p.12

WARNING! When installing and whenever acting on the appliance, ensure that the power supply has been switched off.
For the installation of the spare-part, it is necessary to consult a qualified electrician.

2097/18 A1352031

EN

RL7050100

2097 E14 LAMP HOLDER

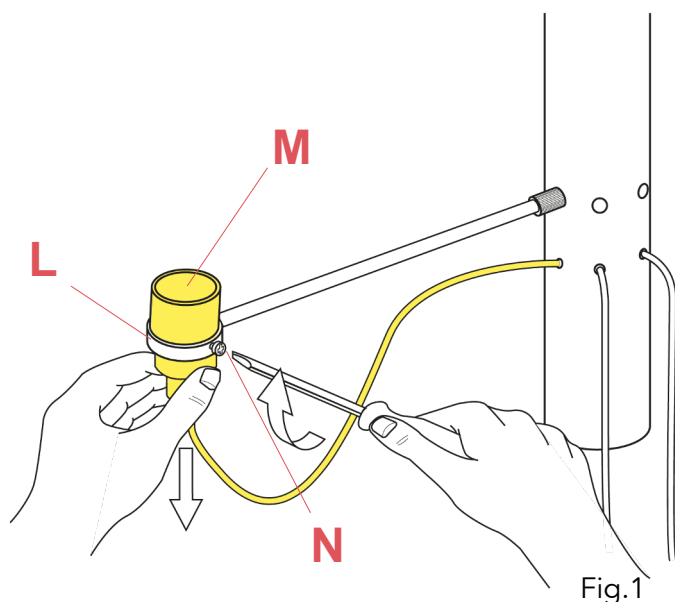

Fig.1

Unfasten the screw (N) and free the lamp holder (M) from the ring of the arm (L) present on the lamp fixture.

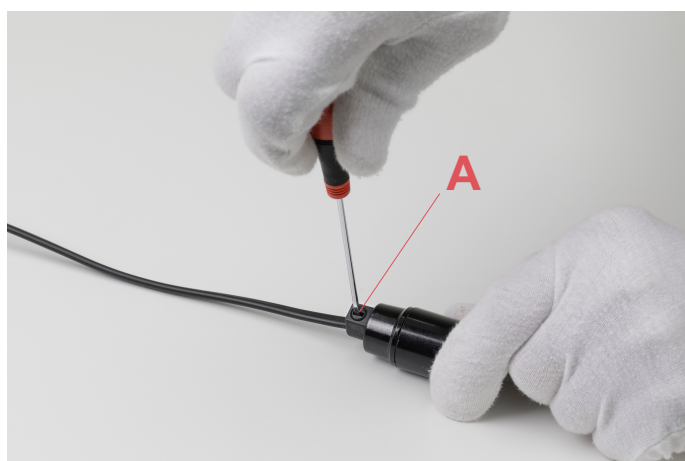

Fig.2

Loosen the screw (A) of the cable clamp on the spare-part kit and also the one present on the lamp fixture.

WARNING! When installing and whenever acting on the appliance, ensure that the power supply has been switched off. For the installation of the spare-part, it is necessary to consult a qualified electrician.

2097/18 A1352031

EN

RL7050100

2097 E14 LAMP HOLDER



Fig.3

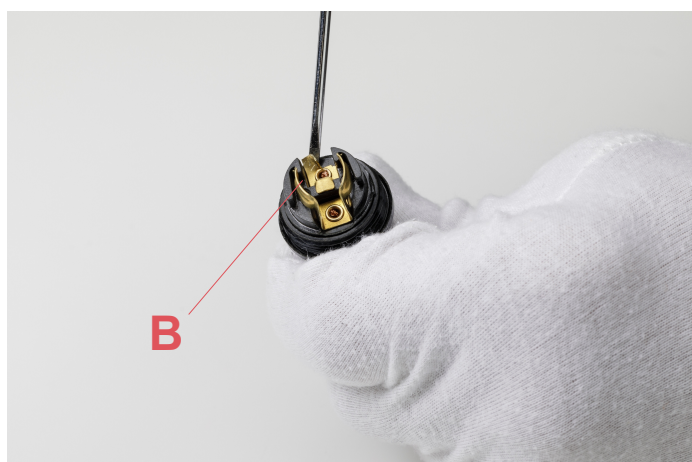

Fig.4

Push down the brass central contact (B) of the fitting of the spare part kit and also on the fitting of the lamp fixture.

WARNING! When installing and whenever acting on the appliance, ensure that the power supply has been switched off. For the installation of the spare-part, it is necessary to consult a qualified electrician.

2097/18 A1352031

EN

RL7050100

2097 E14 LAMP HOLDER



Fig.5

Unfasten the sleeve (C) from the support (D) of the spare-part kit and also on the lamp fixture.

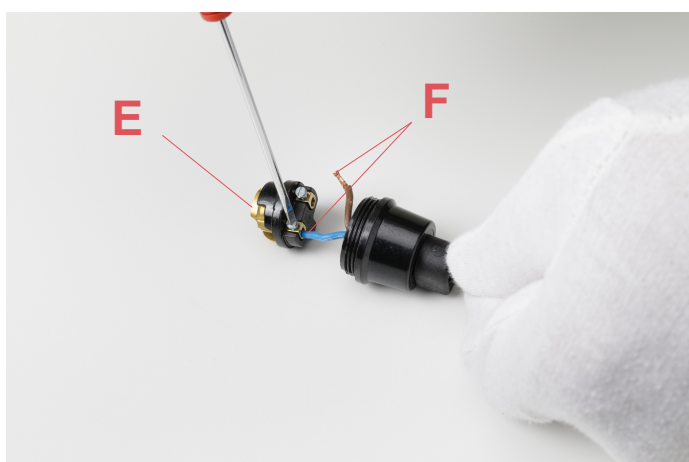

Fig.6

Disconnect the electrical wires (F) from the fitting (E) on the spare-part kit and also on the lamp fixture.
Remove all the components from the electrical cable.

WARNING! When installing and whenever acting on the appliance, ensure that the power supply has been switched off.
For the installation of the spare-part, it is necessary to consult a qualified electrician.

2097/18 A1352031

EN

RL7050100

2097 E14 LAMP HOLDER

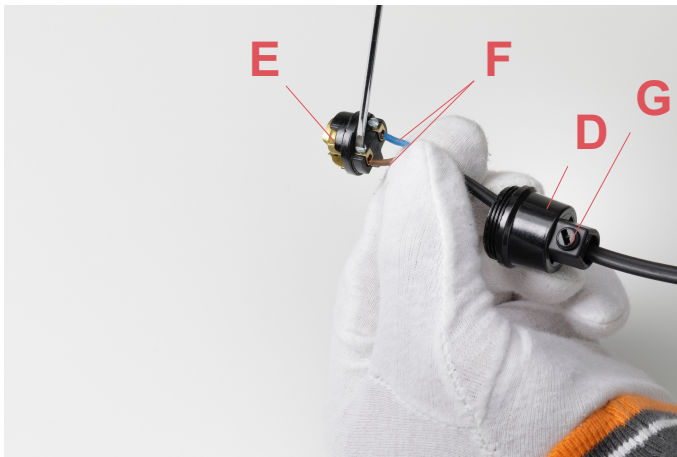

Fig.7



Fig.8

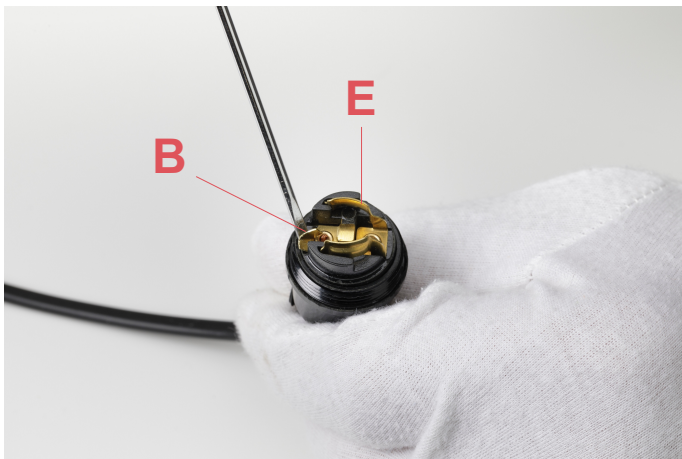

Fig.9

Assemble now the new spare-part:

Insert through the electrical cable the cable clamp (G) and the support (D). Connect the wires (F) on the fitting (E) respecting the polarities.(Fig.7)

Insert the fitting (E) inside the support (D).(Fig.8)

Lift-up the brass central contact (B) on the fitting (E). (Fig.9)

Fasten the sleeve (C) on the support (D).(Fig.5 page 13)

Lock the cable by fastening the screw (A) of the cable clamp.(Fig.2 page 11)

Once replaced the lamp holder it is necessary to insert the lamp holder (M) in the ring (L) and fasten them by locking the screw (N). (Fig.1 page 11)

WARNING! When installing and whenever acting on the appliance, ensure that the power supply has been switched off. For the installation of the spare-part, it is necessary to consult a qualified electrician.

2097/18 A1352031

EN

RF1400100

2097 OPAL BLACK SCREW KIT

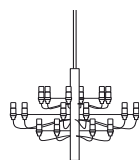

2097/18
p.15

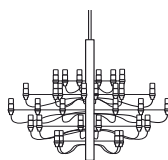

2097/30
p.17

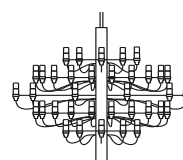

2097/50
p.17

WARNING! When installing and whenever acting on the appliance, ensure that the power supply has been switched off. For the installation of the spare-part, it is necessary to consult a qualified electrician.

2097/18 A1352031

EN

RF1400200

OPAL BLACK LOWER CAP

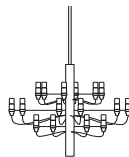

2097/18
p.16

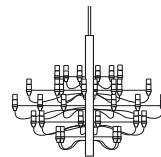

2097/30
p.18

WARNING! When installing and whenever acting on the appliance, ensure that the power supply has been switched off. For the installation of the spare-part, it is necessary to consult a qualified electrician.