

## **BELLHOP BATTERY**

Designed by E. Barber & J. Osgerby, 2018

F1060026

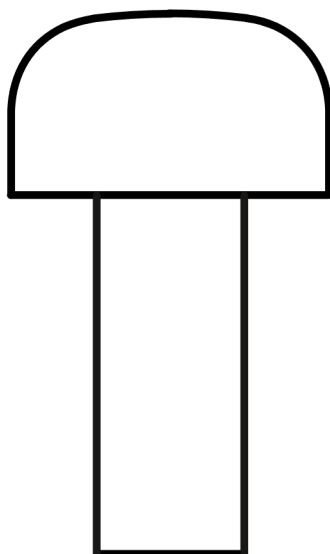

## BELLHOP BATTERY

F1060026

EN

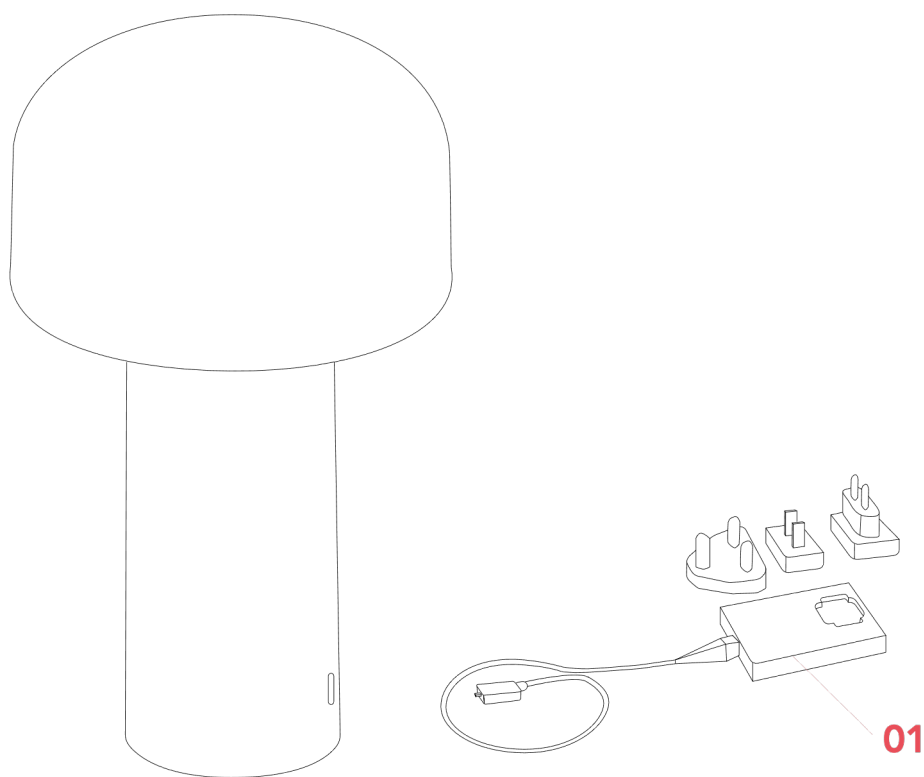

**01. RF1035109** – Power charger whit electrical cable and plugs

**BELLHOP BATTERY**  
F1060026

**EN**

## RF1035109

POWER CHARGER WHIT ELECTRICAL CABLE & PLUGS

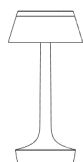
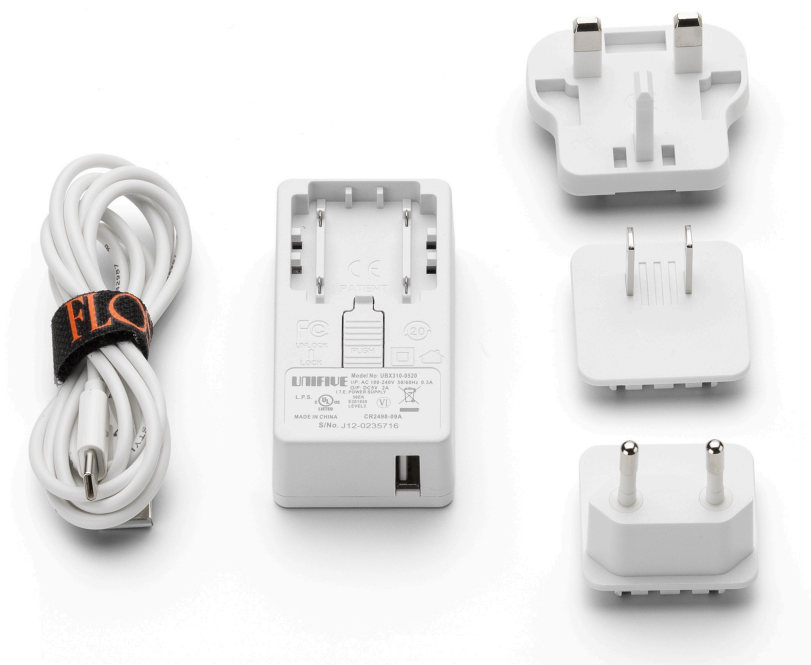

Bon Jour  
Unplugged  
p.10

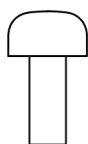

Bellhop  
Battery  
p.03



Last  
Order  
Clear  
p.09



Last  
Order  
Fluted  
p.09

**WARNING!** When installing and whenever acting on the appliance, ensure that the power supply has been switched off. For the installation of the spare-part, it is necessary to consult a qualified electrician.

**BELLHOP BATTERY**  
F1060026

**EN**

## RF1035109

POWER CHARGER WITH ELECTRICAL CABLE & PLUGS

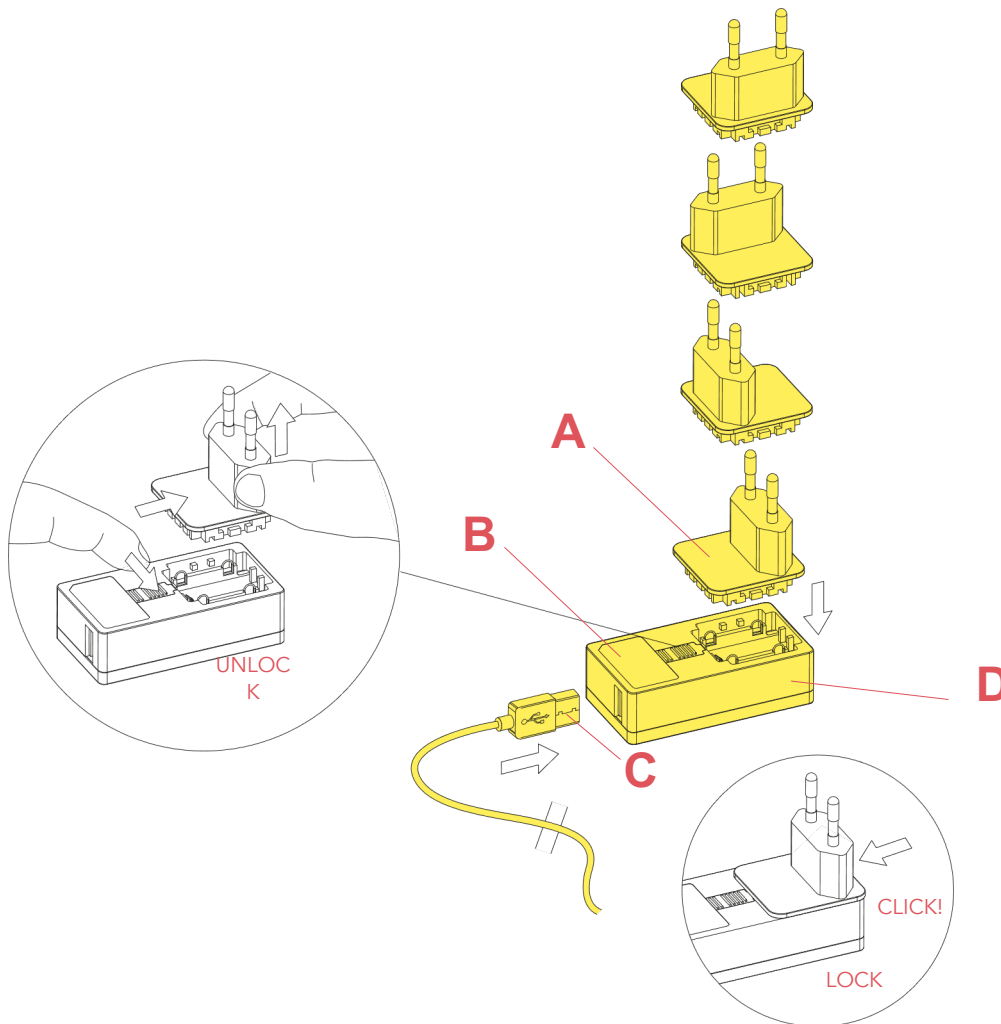

Fig.1

### BATTERY RECHARGE.

Insert the plug (A) into the power adaptor (D) in the working position of your choice (the plug can be inserted into any side of the power adaptor) until you hear the snap-in fastener go click (use the correct type of plug for country the device is installed in); to remove the plug, press the power adaptor's button (B). Insert the USB plug (C) of the cable provided into the power adapter's USB port (E).

WARNING! When installing and whenever acting on the appliance, ensure that the power supply has been switched off. For the installation of the spare-part, it is necessary to consult a qualified electrician.

**BELLHOP BATTERY**  
F1060026

**EN**

**RF1035109**

POWER CHARGER WITH ELECTRICAL CABLE & PLUGS

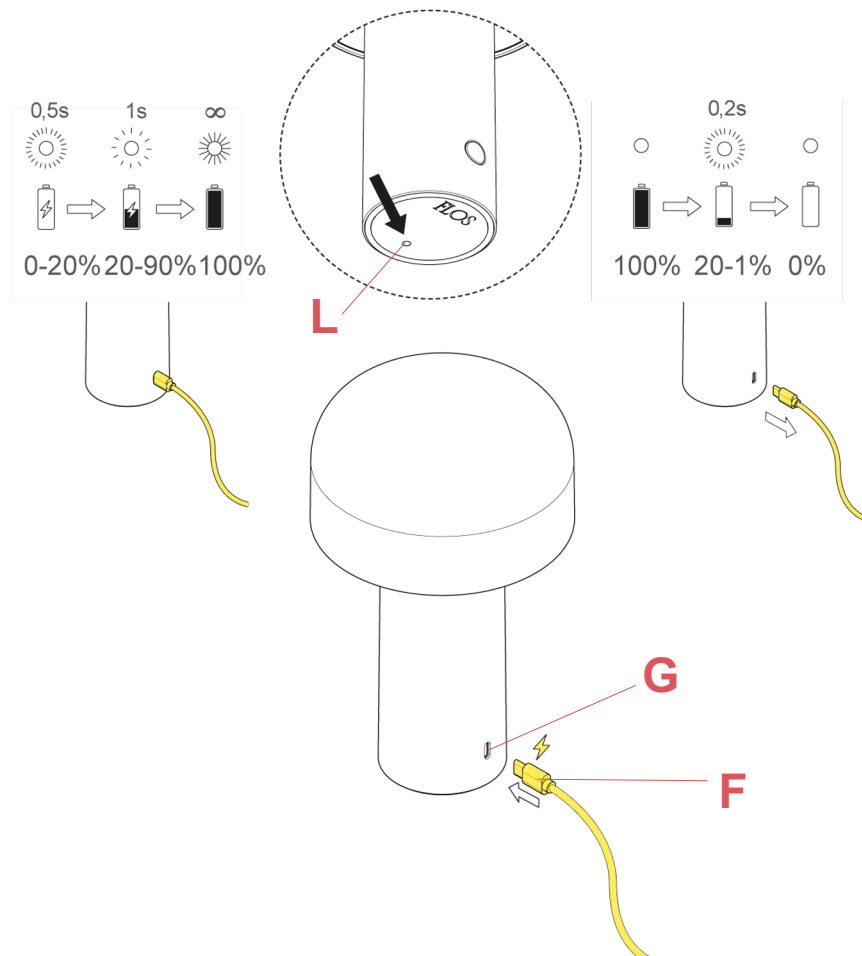

Fig.2

**BATTERY RECHARGE.** Insert the micro-USB plug (F) into the device's connector (G); the recharge status is indicated by the pulse frequency of the led (L) positioned on the base of the device: when the charge level is less than 20% the led flashes at a high frequency (every 0.5 seconds), from 20% to 90% the led flashes at a lower frequency (every 1 second), at full charge the led stays on continuously. The complete charging time is 3 hours. With the device on at 100% light intensity, the wireless operating autonomy is 6 hours (By reducing the light's intensity it is possible to maximise the lifespan up to 24 hours); after 6 hours, the light intensity automatically lowers to 20% and the device signals the need to recharge with a high frequency flashing of the led (L) (every 0.2 seconds) until it is put on charge or until the battery runs down completely. NB: the product is equipped with a self-protection system: if it stays connected to the power adaptor beyond the indicated charging time it won't affect the battery life (500 recharges guaranteed).

WARNING! When installing and whenever acting on the appliance, ensure that the power supply has been switched off. For the installation of the spare-part, it is necessary to consult a qualified electrician.