

BELLHOP WALL UP

Designed by E. Barber & J. Osgerby, 2021

F1080019

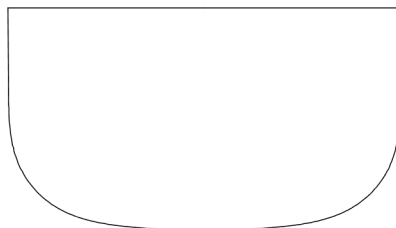

BELLHOP WALL UP

F1080019

EN

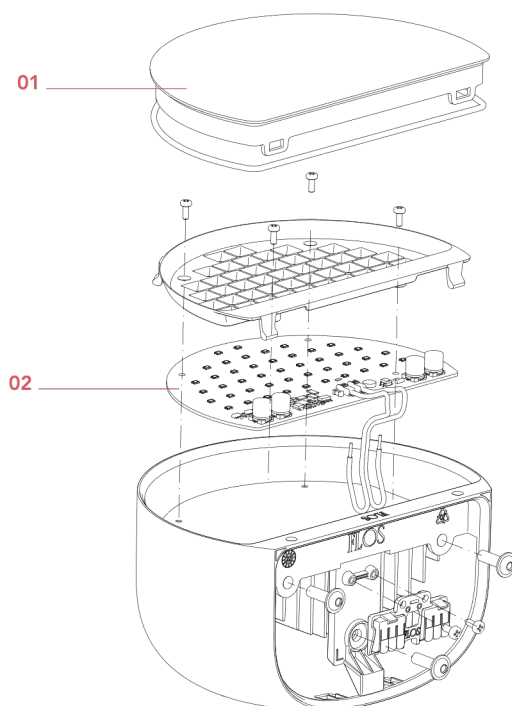

01. RF32828 – Transparent diffuser

02. RF1080100 – Led chip Board

BELLHOP WALL UP
F1080019

EN

RF32828
TRANSPARENT DIFFUSER



WARNING! When installing and whenever acting on the appliance, ensure that the power supply has been switched off.
For the installation of the spare-part, it is necessary to consult a qualified electrician.

©2021 Flos - All rights reserved - www.flos.com
Flos reserves the right to introduce any changes to its own models, without prior notice.

BELLHOP WALL UP
F1080019

EN

RF32828 TRANSPARENT DIFFUSER

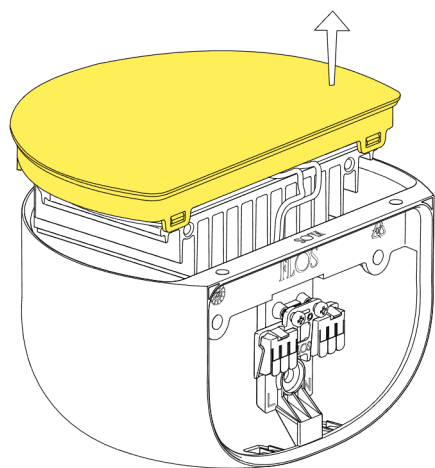

Fig.1

Remove the diffuser assembly from the body lamp.

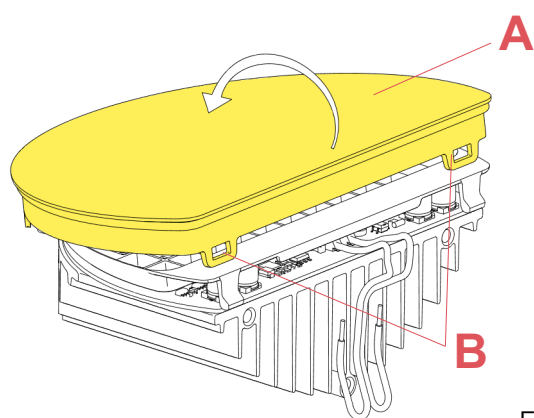

Fig.2

Release the diffuser (A) using the hooks (B).

Assemble now the new spare parts.

WARNING! When installing and whenever acting on the appliance, ensure that the power supply has been switched off. For the installation of the spare-part, it is necessary to consult a qualified electrician.

BELLHOP WALL UP
F1080019

EN

RF1080100
LED CHIP BOARD

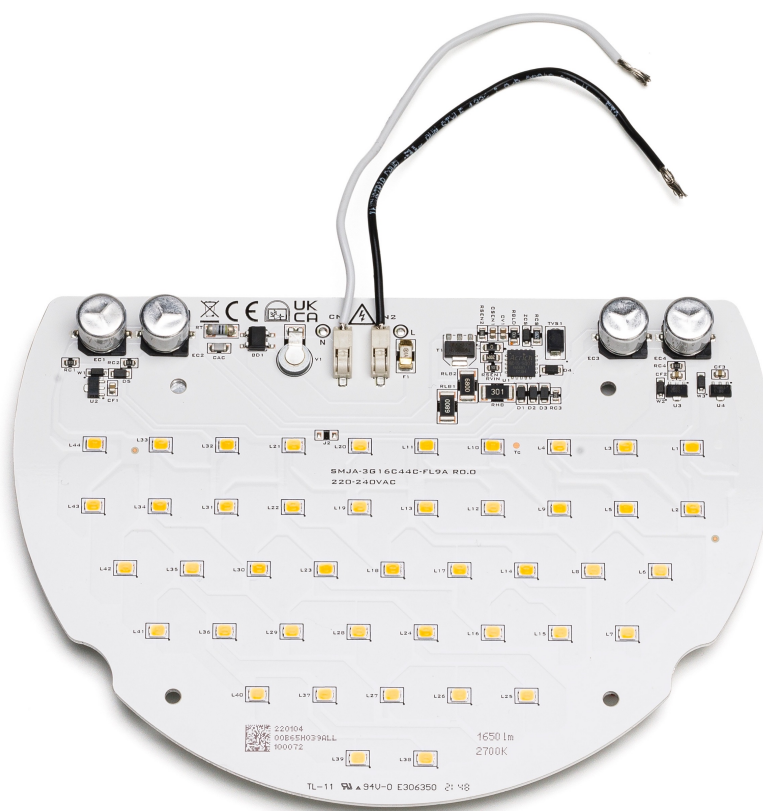

WARNING! When installing and whenever acting on the appliance, ensure that the power supply has been switched off. For the installation of the spare-part, it is necessary to consult a qualified electrician.

BELLHOP WALL UP
F1080019

EN

RF1080100 LED CHIP BOARD

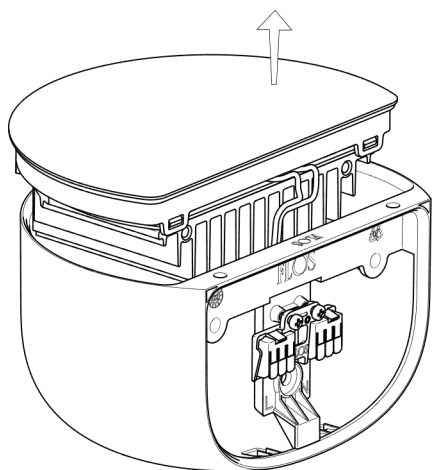

Fig.1

Remove the diffuser assembly from the body lamp.

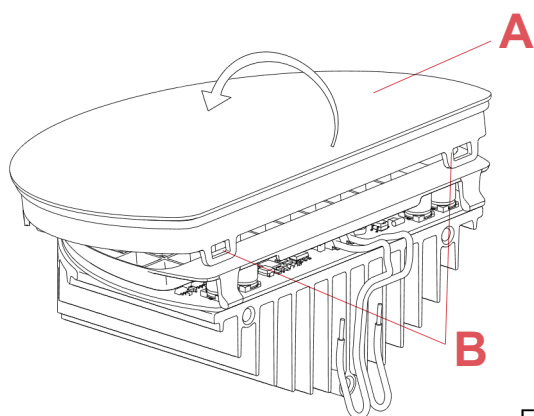

Fig.2

Release the diffuser (A) using the hooks (B).

WARNING! When installing and whenever acting on the appliance, ensure that the power supply has been switched off. For the installation of the spare-part, it is necessary to consult a qualified electrician.

BELLHOP WALL UP
F1080019

EN

RF1080100
LED CHIP BOARD

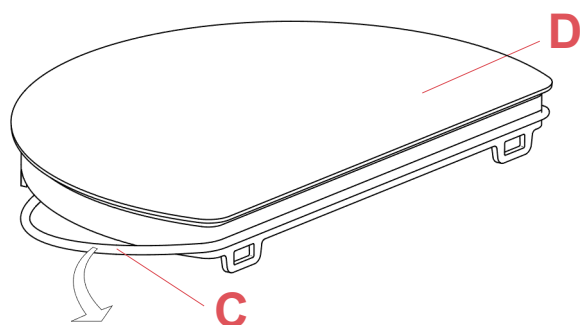

Fig.3

Remove the gasket (C) from the diffuser (D).

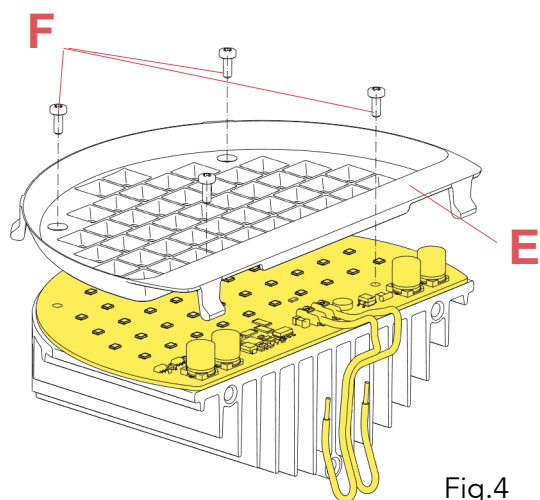

Fig.4

Remove the reflector (E) by unscrewing the 4 screws (F).

WARNING! When installing and whenever acting on the appliance, ensure that the power supply has been switched off. For the installation of the spare-part, it is necessary to consult a qualified electrician.

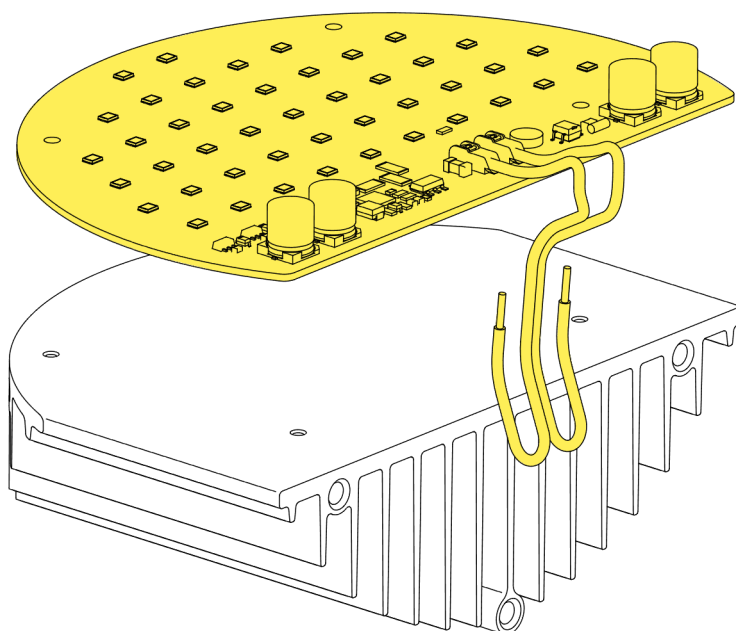
BELLHOP WALL UP
F1080019**EN****RF1080100**
LED CHIP BOARD

Fig.5

Remove the Led chip board.

Assemble now the new spare part.

WARNING! When installing and whenever acting on the appliance, ensure that the power supply has been switched off.
For the installation of the spare-part, it is necessary to consult a qualified electrician.