

SKYGARDEN SMALL

Designed by Marcel Wanders, 2021

F6405044

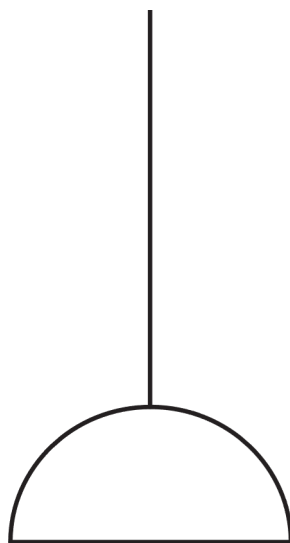

SKYGARDEN SMALL

EN

F6405044

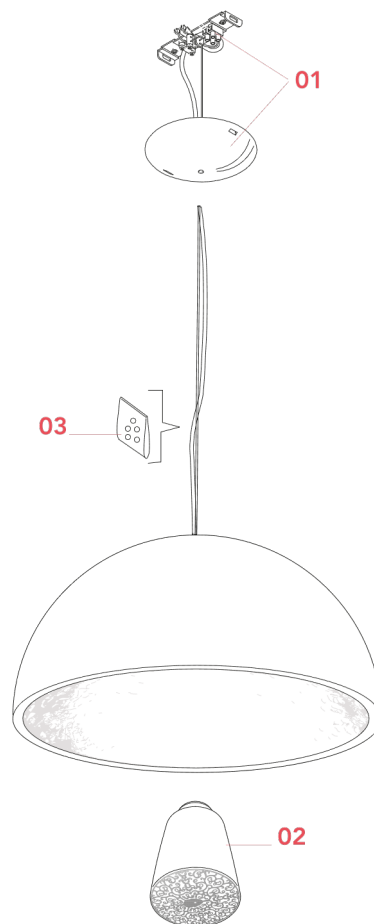

01. RF6410144 – Gold ceiling rose assembly

02. RF31652 – Glass diffuser assembly

03. RF05382 – Kit of quantity 5 OR rings

SKYGARDEN SMALL
F6405044

EN

RF6410144

GOLD CEILING ROSE ASSEMBLY

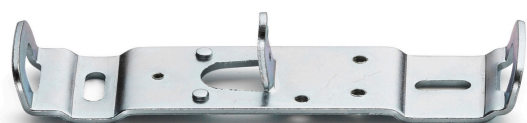

Skygarden 1
p.03



Skygarden
Small
p.03

WARNING! When installing and whenever acting on the appliance, ensure that the power supply has been switched off.
For the installation of the spare-part, it is necessary to consult a qualified electrician.

SKYGARDEN SMALL
F6405044

EN

RF6410144
GOLD CEILING ROSE ASSEMBLY

Fig.1

Fix the wall fixture (A) with the appropriate expansion bolts. **NOTE:** Select and employ screw anchors which are suited to the surface where the appliance is to be installed.

Connect the power cable to the terminal box (not supplied with the spare-part). Mount the ceiling-rose (F).

WARNING! When installing and whenever acting on the appliance, ensure that the power supply has been switched off. For the installation of the spare-part, it is necessary to consult a qualified electrician.

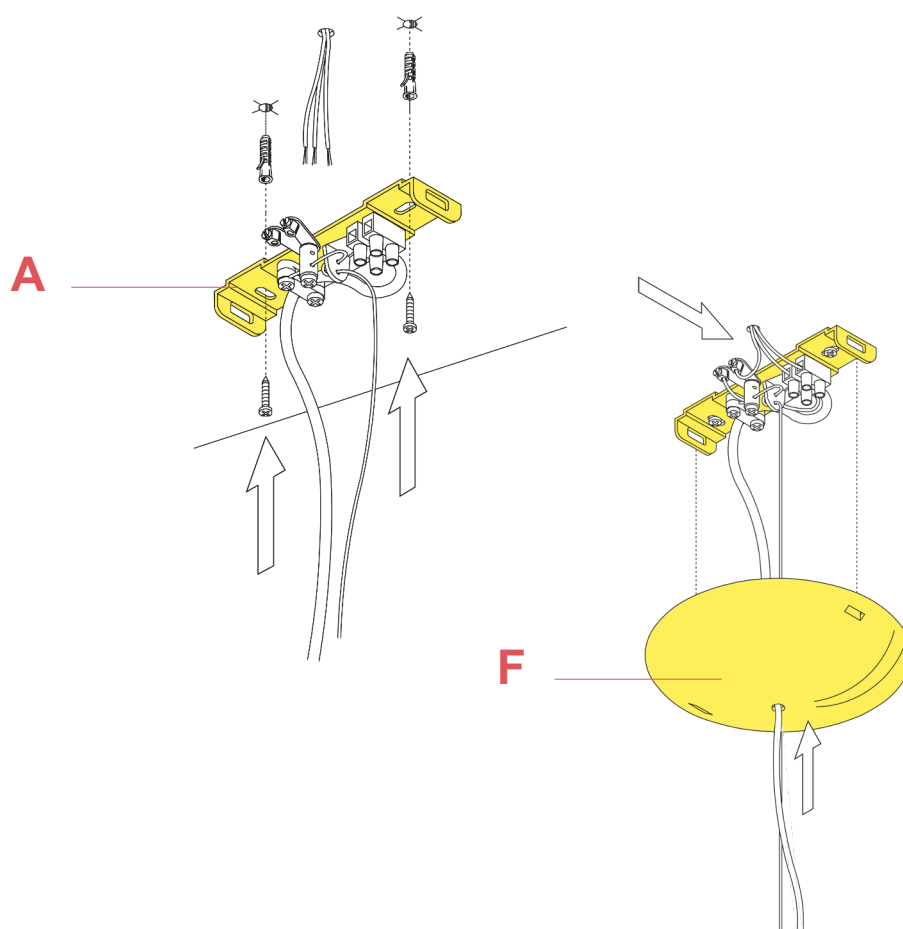
SKYGARDEN SMALL
F6405044

EN

RF31652

GLASS DIFFUSER ASSEMBLY



WARNING! When installing and whenever acting on the appliance, ensure that the power supply has been switched off.
For the installation of the spare-part, it is necessary to consult a qualified electrician.

©2021 Flos - All rights reserved - www.flos.com
Flos reserves the right to introduce any changes to its own models, without prior notice.

SKYGARDEN SMALL
F6405044

EN

RF31652
GLASS DIFFUSER ASSEMBLY

Fig.1

Install the lamp-bulb then assemble the diffuser (A) on the body by fastening it onto the appropriate threaded screw (B).

WARNING! Screw on the diffuser (A) by keeping it perpendicular to the threaded screw (B).

REMARK!!! Screw on the diffuser without forcing. Once reaching the end of the thread loosen slightly to make it easy for a future removal.

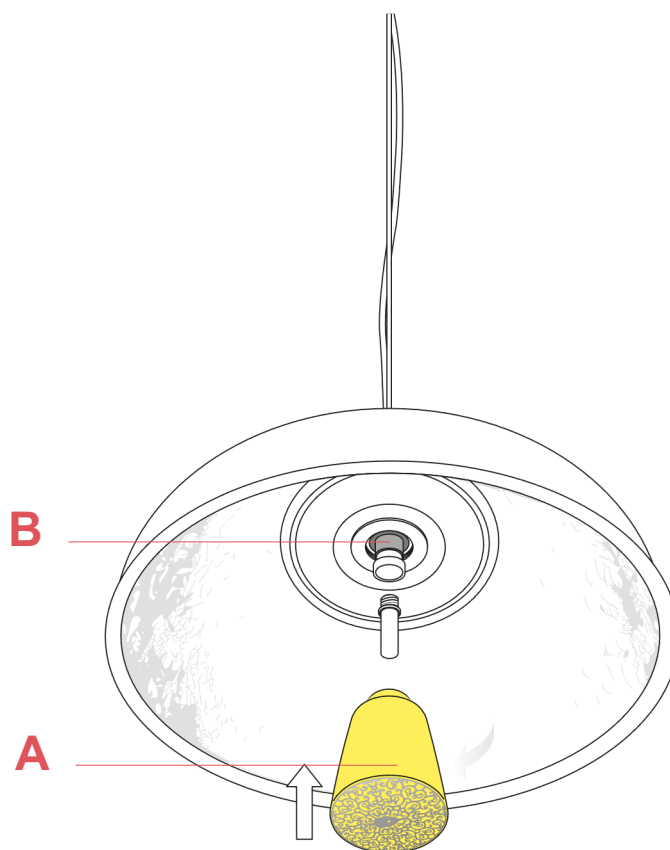
WARNING! When installing and whenever acting on the appliance, ensure that the power supply has been switched off. For the installation of the spare-part, it is necessary to consult a qualified electrician.

SKYGARDEN SMALL
F6405044

EN

RF31652

GLASS DIFFUSER ASSEMBLY

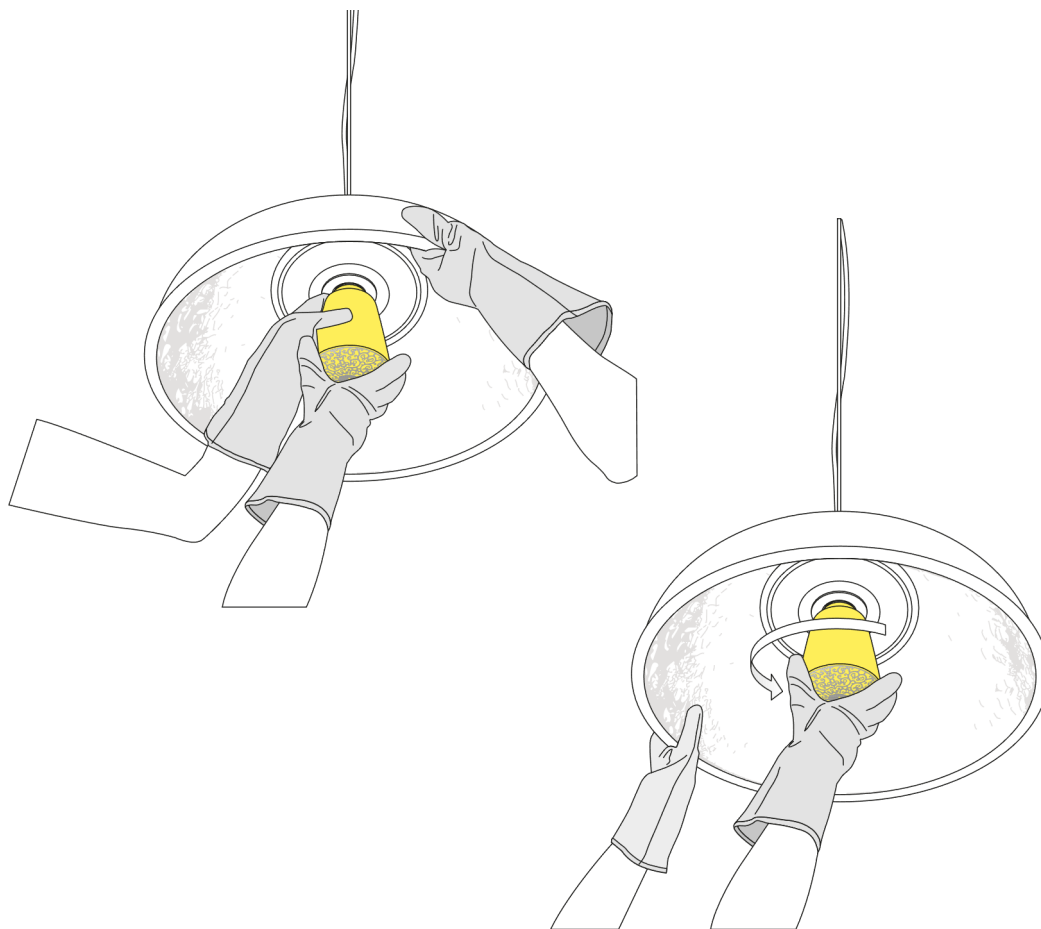

Fig.2

LAMP-BULB REPLACEMENT INSTRUCTIONS

Ensure that power has been turned off.

Check that the bulb is not too hot.

Wait 30 minutes with the bulb off before trying the procedure (the lamp bulb must be cold).

It is advisable to do this operation wearing clean gloves.

Keep the body lamp (C) firm with one hand and with the other hand remove the glass diffuser (A) by turning it anti-clockwise.

Should you encounter any problems with the removal of the diffuser ask another person to keep the body lamp firm and use both hands to remove the diffuser.

WARNING! When installing and whenever acting on the appliance, ensure that the power supply has been switched off. For the installation of the spare-part, it is necessary to consult a qualified electrician.

SKYGARDEN SMALL
F6405044

EN

RF05382

KIT OF QUANTITY 5 OR RINGS



Glo-ball
S1
p.18



Glo-ball
S2
p.17



Skygarden
1
p.08

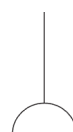

Skygarden
2
p.08



Skygarden
Small
p.08



Smithfield
S
p.05



Smithfield
S Pro
p.05



Tatou
S2
p.11

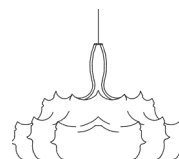

Zeppelin 1
p.05

WARNING! When installing and whenever acting on the appliance, ensure that the power supply has been switched off. For the installation of the spare-part, it is necessary to consult a qualified electrician.