

SMITHFIELD S PRO

Designed by Jasper Morrison, 2009

F1367021

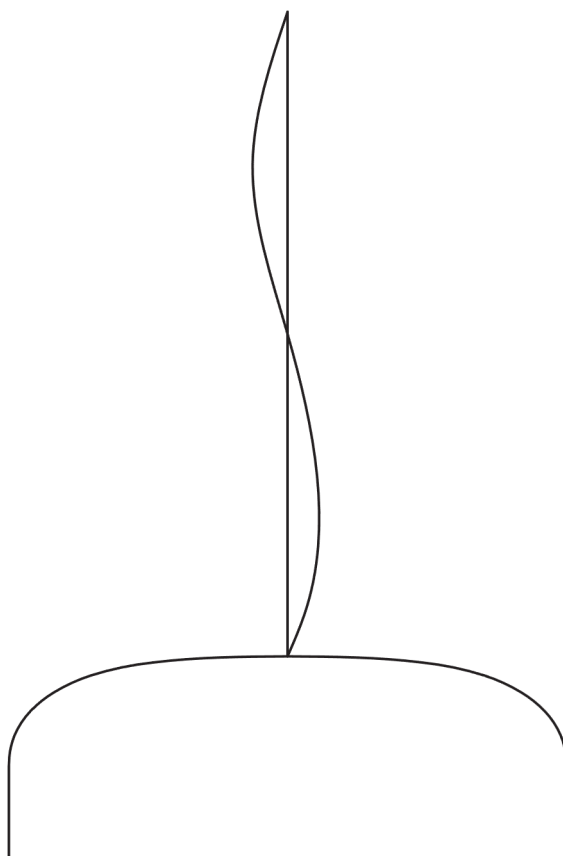

SMITHFIELD S PRO

F1367021

EN

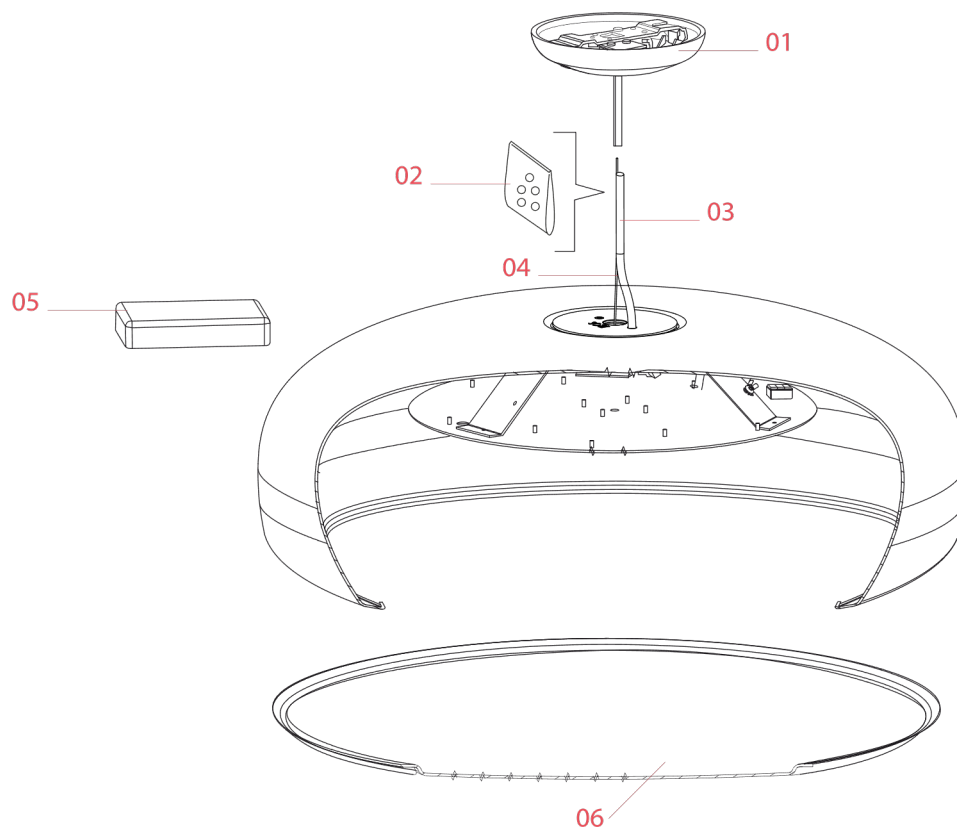

- 01. RA3690221 – Mud black rose assembly
- 02. RF05382 – Kit of 5 OR rings
- 03. RF29934 – 2,7mt FEP/SIL 5x0,75 transparent cable
- 04. RF29665 – 2,7mt steel wire Ø1,2mm with 19 winded wires
- 05. RF24191 – Led Power supply
- 06. RF19022 – Methacrylate diffuser

SMITHFIELD S PRO F1367021

EN

RA3690221

MUD ROSE ASSEMBLY

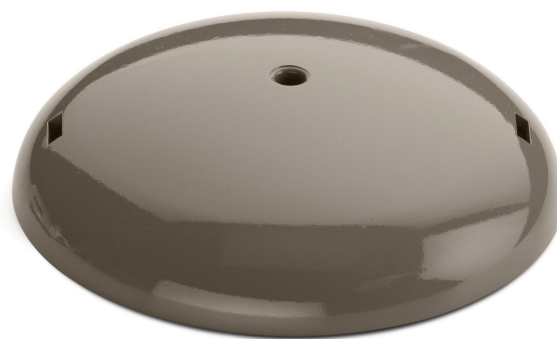
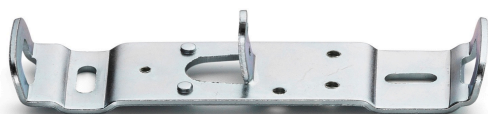

Smithfield
S
p.03

Smithfield
S Pro
p.03

WARNING! When installing and whenever acting on the appliance, ensure that the power supply has been switched off.
For the installation of the spare-part, it is necessary to consult a qualified electrician.

RA3690221

MUD ROSE ASSEMBLY

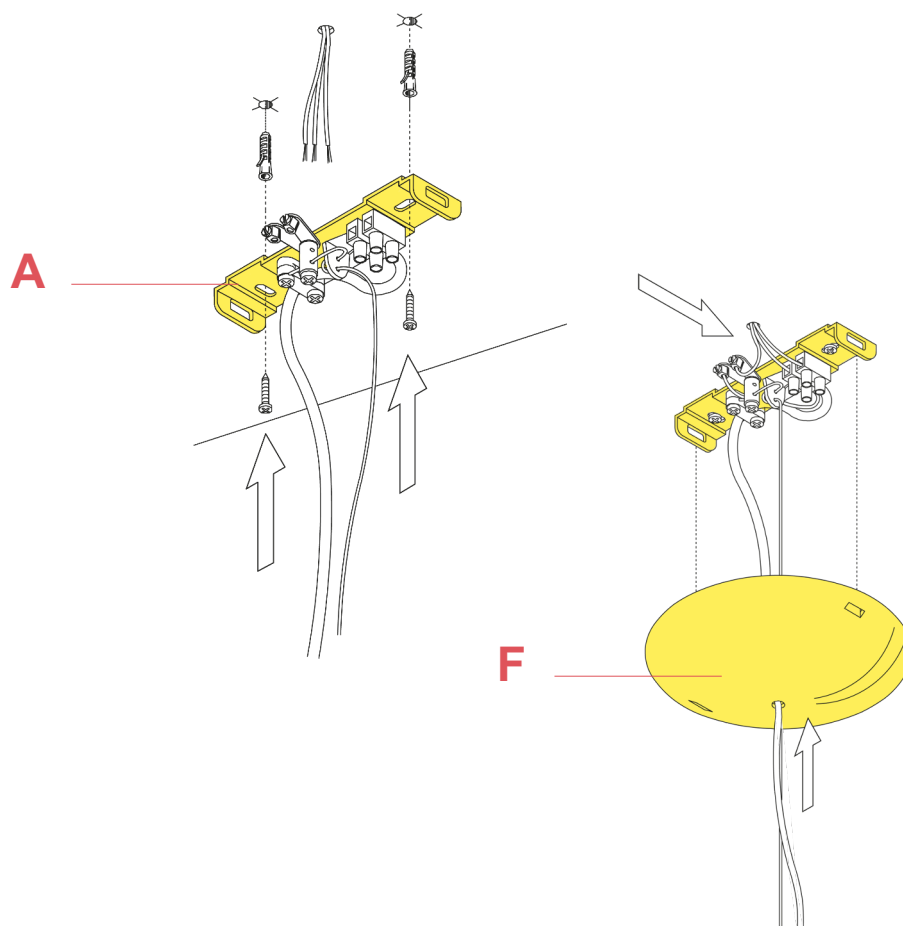

Fig.1

Fix the wall fixture (A) with the appropriate expansion bolts.

NOTE: Select and employ screw anchors which are suited to the surface where the appliance is to be installed.

Connect the power cable to the terminal box (not supplied with the spare-part). Mount the ceiling-rose (F).

WARNING! When installing and whenever acting on the appliance, ensure that the power supply has been switched off. For the installation of the spare-part, it is necessary to consult a qualified electrician.

SMITHFIELD S PRO F1367021

EN

RF05382

KIT OF 5 OR RINGS



Glo-ball
S1
p.18



Glo-ball
S2
p.17



Skygarden
1
p.08

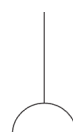

Skygarden
2
p.08



Skygarden
Small
p.08



Smithfield
S
p.05



Smithfield
S Pro
p.05



Tatou
S2
p.11

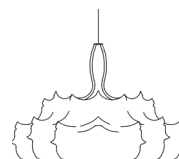

Zeppelin 1
p.05

WARNING! When installing and whenever acting on the appliance, ensure that the power supply has been switched off. For the installation of the spare-part, it is necessary to consult a qualified electrician.

SMITHFIELD S PRO F1367021

EN

RF29934

2,7MT FEP/PVC 5X0,75 TRANSPARENT CABLE



WARNING! When installing and whenever acting on the appliance, ensure that the power supply has been switched off.
For the installation of the spare-part, it is necessary to consult a qualified electrician.

SMITHFIELD S PRO F1367021

EN

RF29665

STEEL CABLE 2,7 MT Ø1,2 WITH 19 WINDED WIRES

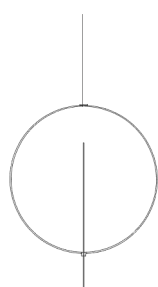

Overlap
p.09



Ray S
p.10



Smithfield
S
p.07



Smithfield
S Pro
p.07

WARNING! When installing and whenever acting on the appliance, ensure that the power supply has been switched off. For the installation of the spare-part, it is necessary to consult a qualified electrician.

SMITHFIELD S PRO F1367021

EN

RF24191
LED POWER SUPPLY

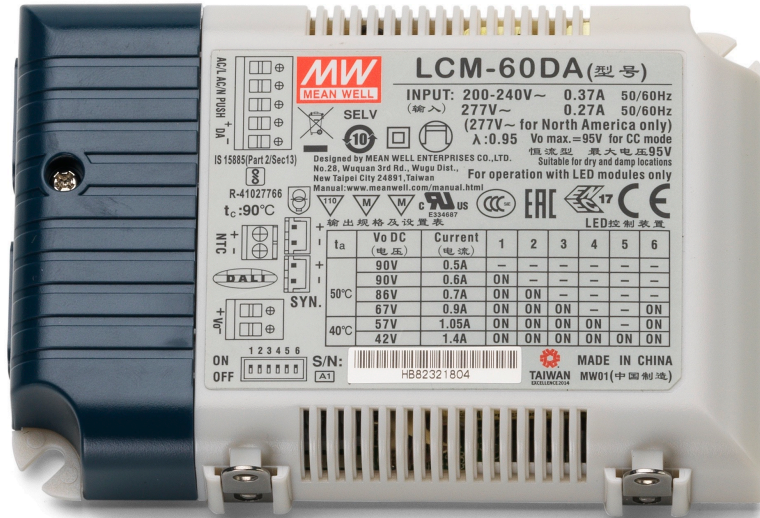

Smithfield
C Pro
p.03



Smithfield
S Pro
p.08

WARNING! When installing and whenever acting on the appliance, ensure that the power supply has been switched off. For the installation of the spare-part, it is necessary to consult a qualified electrician.

SMITHFIELD S PRO F1367021

EN

RF19022

METHACRYLATE DIFFUSER



Smithfield
C
p.03



Smithfield
C Pro
p.04



Smithfield
S
p.09

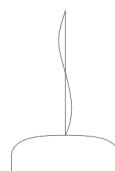

Smithfield
S Pro
p.09

WARNING! When installing and whenever acting on the appliance, ensure that the power supply has been switched off.
For the installation of the spare-part, it is necessary to consult a qualified electrician.

SMITHFIELD S PRO F1367021

EN

RF19022

METHACRYLATE DIFFUSER

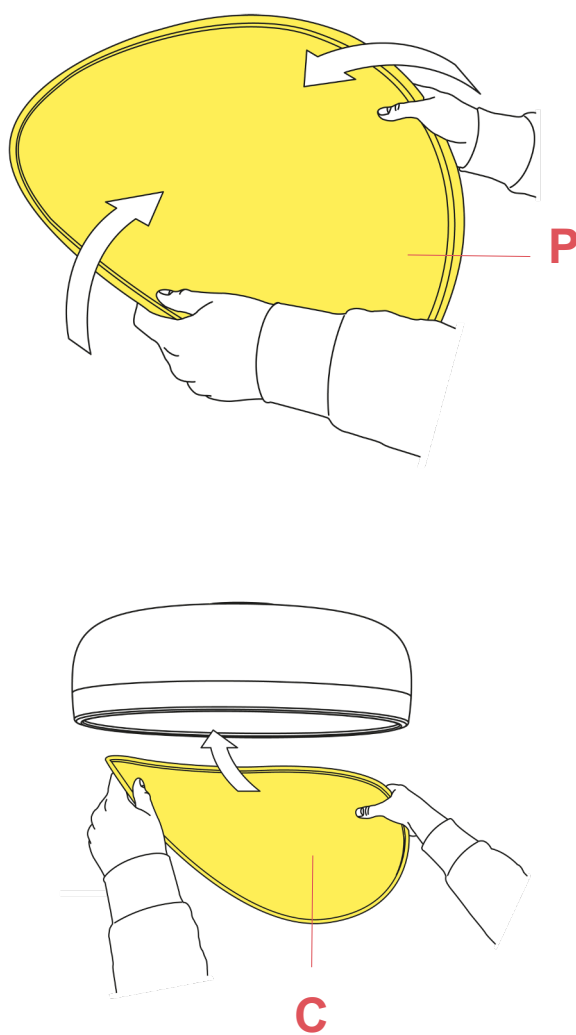

Fig.1

Mount the plastic diffuser (P) bending it slightly on the sides to ease it into the body.

WARNING! When installing and whenever acting on the appliance, ensure that the power supply has been switched off. For the installation of the spare-part, it is necessary to consult a qualified electrician.