

## SMITHFIELD S

Designed by Jasper Morrison, 2009

F1371009

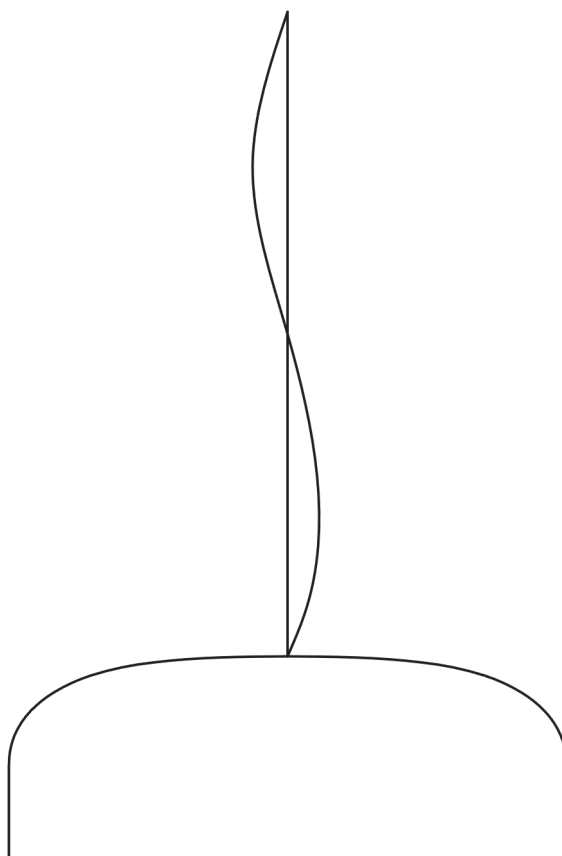

## SMITHFIELD S

F1371009

EN

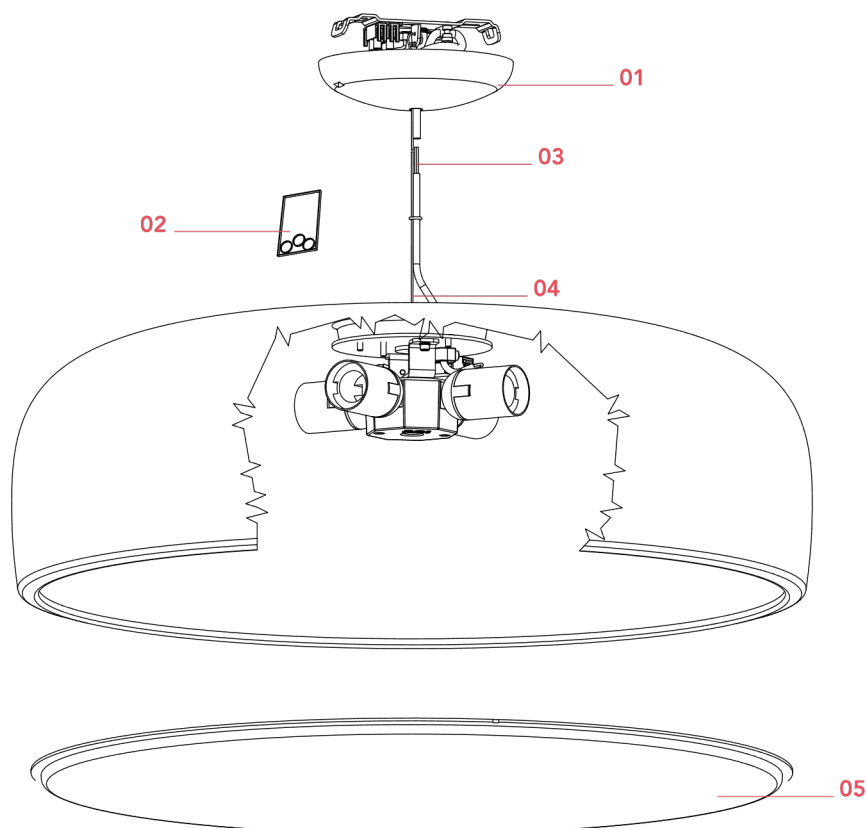

**01. RA3690209** – White rose assembly

**02. RF05382** – Kit of 5 OR rings

**03. RF29907** – 2,7mt FEP/SIL 3x0,75 transparent cable

**04. RF29665** – 2,7mt steel wire Ø1,2mm with 19 winded wires

**05. RF19022** – Methacrylate diffuser

SMITHFIELD S F1371009

EN

## RA3690209

WHITE CEILING ROSE ASSEMBLY



Chasen  
p.03



Glo-ball  
S1  
p.03



Glo-ball  
S2  
p.03



Skygarden  
1  
p.03



Skygarden  
Small  
p.03



Smithfield S  
p.03



Smithfield  
S Pro  
p.03



Taraxacum  
S1 Cocoon  
p.03



Taraxacum  
S2 Cocoon  
p.03



Viscontea  
p.03

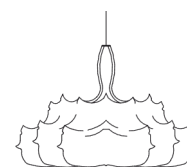

Zeppelin 1  
p.03

WARNING! When installing and whenever acting on the appliance, ensure that the power supply has been switched off. For the installation of the spare-part, it is necessary to consult a qualified electrician.

SMITHFIELD S F1371009

EN

**RA3690209**

WHITE CEILING ROSE ASSEMBLY

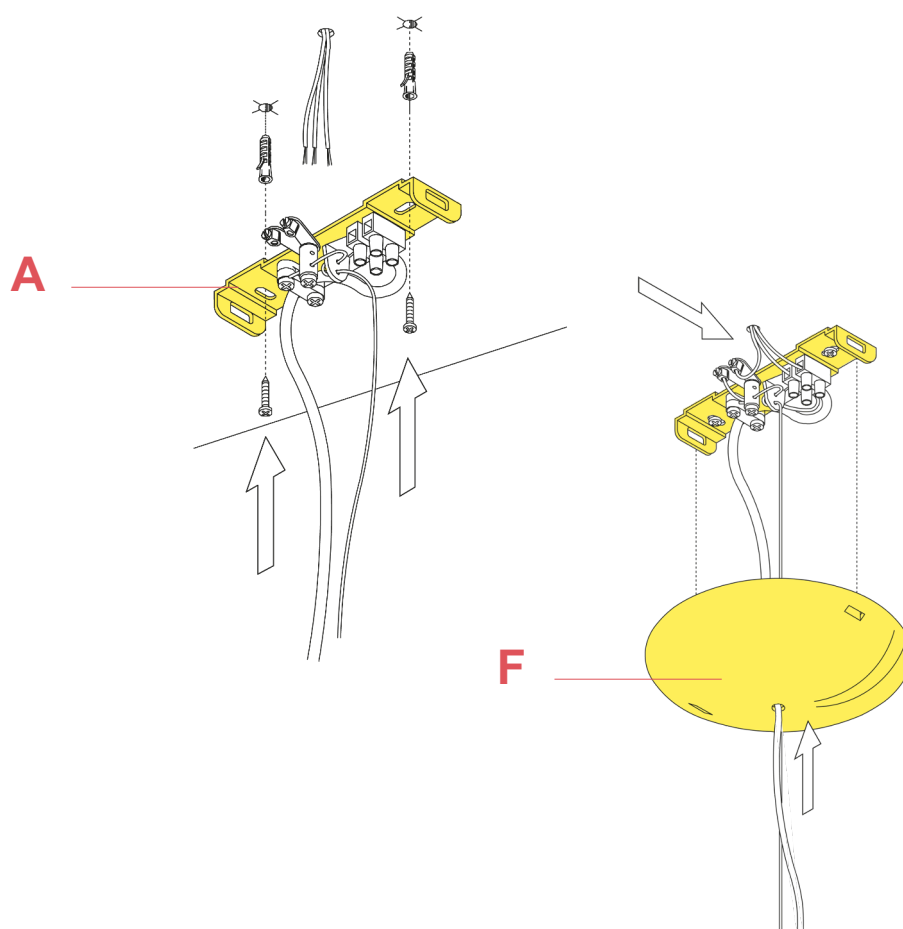

Fig.1

Fix the wall fixture (A) with the appropriate expansion bolts.

**NOTE:** Select and employ screw anchors which are suited to the surface where the appliance is to be installed.

Connect the power cable to the terminal box (not supplied with the spare-part). Mount the ceiling-rose (F).

WARNING! When installing and whenever acting on the appliance, ensure that the power supply has been switched off. For the installation of the spare-part, it is necessary to consult a qualified electrician.

SMITHFIELD S F1371009

EN

## RF05382

KIT OF QUANTITY 5 OR RINGS



Glo-ball  
S1  
p.18



Glo-ball  
S2  
p.17



Skygarden  
1  
p.08

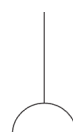

Skygarden  
2  
p.08



Skygarden  
Small  
p.08



Smithfield  
S  
p.05



Smithfield  
S Pro  
p.05



Tatou  
S2  
p.11

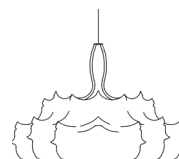

Zeppelin 1  
p.05

WARNING! When installing and whenever acting on the appliance, ensure that the power supply has been switched off. For the installation of the spare-part, it is necessary to consult a qualified electrician.

SMITHFIELD S F1371009

EN

## RF29907

2,7MT FEP/PVC 3X0,75 TRANSPARENT CABLE



WARNING! When installing and whenever acting on the appliance, ensure that the power supply has been switched off.  
For the installation of the spare-part, it is necessary to consult a qualified electrician.

©2021 Flos - All rights reserved - [www.flos.com](http://www.flos.com)  
Flos reserves the right to introduce any changes to its own models, without prior notice.

SMITHFIELD S F1371009

EN

## RF29665

STEEL CABLE 2,5MT Ø1,2 WITH 19 WINDED WIRES

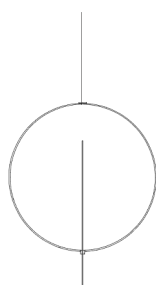

Overlap  
p.09



Ray S  
p.10



Smithfield  
S  
p.07

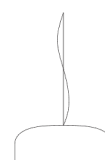

Smithfield  
S Pro  
p.07

WARNING! When installing and whenever acting on the appliance, ensure that the power supply has been switched off. For the installation of the spare-part, it is necessary to consult a qualified electrician.

SMITHFIELD S F1371009

EN

## RF19022

METHACRYLATE DIFFUSER



Smithfield  
C  
p.03



Smithfield  
C Pro  
p.04



Smithfield  
S  
p.09



Smithfield  
S Pro  
p.09

WARNING! When installing and whenever acting on the appliance, ensure that the power supply has been switched off.  
For the installation of the spare-part, it is necessary to consult a qualified electrician.



SMITHFIELD S F1371009

EN

**RF19022**

METHACRYLATE DIFFUSER

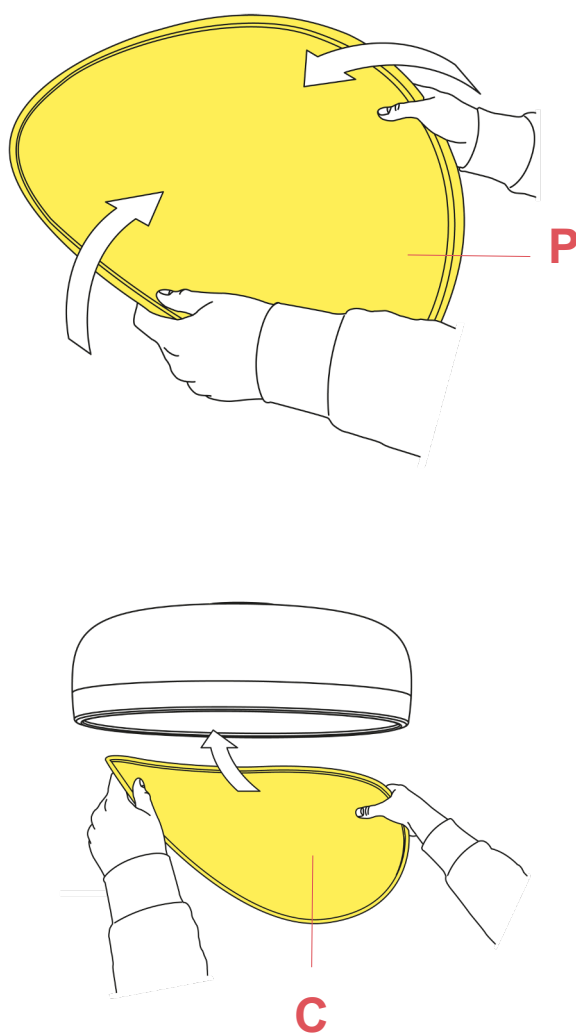

Fig.1

Mount the plastic diffuser (P) bending it slightly on the sides to ease it into the body.

WARNING! When installing and whenever acting on the appliance, ensure that the power supply has been switched off. For the installation of the spare-part, it is necessary to consult a qualified electrician.